

Aspire 1360/1520 Series

Service Guide

PRINTED IN TAIWAN

Revision History

Please refer to the table below for the updates made on Aspire 1360/1520 service guide.

Date	Chapter	Updates
2004/10/20	Chapter 1	Add the most up-to-date system block diagram on page 3. Change the memory controller to "built-in CPU" on page 18.

Copyright

Copyright © 2004 by Acer Incorporated. All rights reserved. No part of this publication may be reproduced, transmitted, transcribed, stored in a retrieval system, or translated into any language or computer language, in any form or by any means, electronic, mechanical, magnetic, optical, chemical, manual or otherwise, without the prior written permission of Acer Incorporated.

Disclaimer

The information in this guide is subject to change without notice.

Acer Incorporated makes no representations or warranties, either expressed or implied, with respect to the contents hereof and specifically disclaims any warranties of merchantability or fitness for any particular purpose. Any Acer Incorporated software described in this manual is sold or licensed "as is". Should the programs prove defective following their purchase, the buyer (and not Acer Incorporated, its distributor, or its dealer) assumes the entire cost of all necessary servicing, repair, and any incidental or consequential damages resulting from any defect in the software.

Intel is a registered trademark of Intel Corporation.

Pentium and Pentium II/III are trademarks of Intel Corporation.

Other brand and product names are trademarks and/or registered trademarks of their respective holders.

Conventions

The following conventions are used in this manual:

Screen messages	Denotes actual messages that appear on screen.
NOTE	Gives bits and pieces of additional information related to the current topic.
WARNING	Alerts you to any damage that might result from doing or not doing specific actions.
CAUTION	Gives precautionary measures to avoid possible hardware or software problems.
IMPORTANT	Reminds you to do specific actions relevant to the accomplishment of procedures.

Preface

Before using this information and the product it supports, please read the following general information.

1. This Service Guide provides you with all technical information relating to the BASIC CONFIGURATION decided for Acer "global" product offering. To better fit local market requirements and enhance product competitiveness, your regional office MAY have decided to extend the functionality of a machine (e.g. add-on card, modem, or extra memory capability). These LOCALIZED FEATURES will NOT be covered in this generic service guide. In such cases, please contact your regional offices or the responsible personnel/channel to provide you with further technical details.
2. Please note WHEN ORDERING FRU PARTS, that you should check the most up-to-date information available on your regional web or channel. If, for whatever reason, a part number change is made, it will not be noted in the printed Service Guide. For ACER AUTHORIZED SERVICE PROVIDERS, your Acer office may have a DIFFERENT part number code to those given in the FRU list of this printed Service Guide. You MUST use the list provided by your regional Acer office to order FRU parts for repair and service of customer machines.

Table of Contents

Chapter 1	System Introduction	1
	Features	1
	System Block Diagram	3
	Board Layout	4
	Top View	4
	Bottom View	5
	Panel	6
	Front View	6
	Left view	7
	Right View	8
	Rear Panel	9
	Bottom View	10
	Indicators	11
	Keyboard	12
	Special keys	12
	Hot Keys	15
	Hardware Specifications and Configurations	18
Chapter 2	System Utilities	32
	BIOS Setup Utility	32
	Navigating the BIOS Utility	33
	Information	34
	Main	35
	Advanced	37
	Security	39
	Boot	43
	Exit	44
	BIOS Flash Utility	45
Chapter 3	Machine Disassembly and Replacement	46
	General Information	47
	Before You Begin	47
	Disassembly Procedure Flowchart	48
	Removing the Battery	50
	Removing the Memory Module	51
	Removing the Wireless LAN Board and the Modem Board	52
	Removing the Hard Disk Drive Module	53
	Disassembling the Hard Disk Drive Module	53
	Removing the LCD Module	54
	Removing the Middle Cover	54
	Removing the Launch Board	54
	Removing the LCD Module	55
	Disassembling the LCD Module	57
	Removing the LCD Bezel	57
	Removing the Inverter Board (15" LCD)	57
	Removing the 15" TFT LCD	58
	Removing the LCD Brackets	59
	Removing the LCD Coaxial Cable	59
	Removing the LCD Hinges	60
	Disassembling the Main Unit	61
	Removing the Keyboard	61
	Removing the RTC Battery	61

Table of Contents

Removing the Fan	61
Removing the Thermal Module	62
Removing the Processor	62
Installing the Processor	63
Removing the Upper Case Assembly	63
Removing the Touchpad Board	64
Removing the Touchpad Cable	64
Removing the VGA Thermal Plate	65
Removing the CPU Heatsink Plate	65
Removing the Second Fan Bracket	66
Removing the ODD Module(1)	66
Removing the ODD Module(2)	66
Removing the HDD Bracket	67
Removing the Main Board	67
Removing the DC Board	68
Removing the I/O Port Bracket	68
Removing the PCMCIA Slot	69
Removing the Speaker Set	70
System Upgrade Procedure	71
Base Unit to Wireless Unit	71
Chapter 4 Troubleshooting	72
System Check Procedures	73
External Diskette Drive Check	73
External CD-ROM Drive Check	73
Keyboard or Auxiliary Input Device Check	73
Memory check	74
Power System Check	74
Touchpad Check	76
Power-On Self-Test (POST) Error Message	77
Index of Error Messages	78
POST Code	81
Index of Symptom-to-FRU Error Message	85
Intermittent Problems	88
Undetermined Problems	89
How to Build NAPP Master Hard Disc Drive	90
CD to Disk Recovery	90
Disk to Disk Recovery	93
Chapter 5 Jumper and Connector Locations	98
Top View	98
Bottom View	99
Chapter 6 FRU (Field Replaceable Unit) List	100
Aspire 1660 Exploded Diagram	101
Appendix A Model Definition and Configuration	112
Model Name Definition	112
Appendix B Test Compatible Components	114
Microsoft Windows XP Environment Test	115
Appendix C Online Support Information	120

System Introduction

Features

This computer was designed with the user in mind. Here are just a few of its many features:

Performance

- Mobile AMD Sempron™ processor 2600+ to 3300+ or higher with 128/256 KB L2 cache, supporting AMD Power Now! Technology and HyperTransport technology (for Aspire 1360 only)
- AMD Athlon 64 processor 3000+ to 3400+ or higher with 1 MB cache, supporting HyperTransport technology (for Aspire 1520 only)
- VIA Chipset-integrated Unichrome PRO graphics core, with up to 64MB of shared memory
- 256/512MB of DDR333 SDRAM, upgradeable to 2048MB with dual soDIMM modules
- 30GB and above high-capacity, Enhanced-IED hard disk (for Aspire 1360 only)
- 40GB and above high-capacity, Enhanced-IDE hard disk (for Aspire 1520 only)
- Advanced Configuration Power Interface (ACPI) power management system

Display

- The TFT LCD panel providing a large viewing area for maximum efficiency and ease-of-use:
 - 14.1" XGA (1024x768) resolution (for Aspire 1360 only)
 - 15.0" XGA (1024x768) or SXGA+ (1400x1050) resolution
 - 15.4" WXGA (1280x800)
- NVIDIA GeForce4 448 Go with 64MB of video memory (manufacturing option)
- NVIDIA GeForce FX Go5200 with 64MB of video memory (manufacturing option)
- NVIDIA GeForce FX Go5700 with 64MB of video memory (manufacturing option)
- 3D graphics support
- Support simultaneous display between LCD and CRT
- S-video for output to a television or display device that supports S-video input
- "Automatic LCD dim" feature, automatically selecting the best setting for the display in order to conserve power
- DualView™ support

Multimedia

- High-speed built-in optical drive:
 - DVD/CD-RW Combo, or DVD-Dual or DVD Super-Multi
- MS DirectSound compatible
- Built-in dual speakers

Connectivity

- Integrated 10/100 Mbps Fast Ethernet connection (for Aspire 1360 only)
- Integrated 10/100/1000 Mbps Fast Ethernet connection (for Aspire 1520 only)
- Built-in 56Kbps fax/data modem

-
- Four Universal Serial Bus (USB) 2.0 ports
 - One IEEE 1394 port
 - IEEE 802.11b/g Wireless LAN (manufacturing option)
 - Bluetooth® (manufacturing option)

Expansion

- One Type III or two Type II CardBus PC Card slots
- Upgradeable hard disk and memory modules

Human-centric design

- Rugged, yet extremely portable, construction
- Stylish appearance
- Full-size keyboard with four programmable launch keys
- Comfortable palm rest area with well-positioned touchpad

I/O Ports

- Two Type II or one Type III PC CardBus (PCMCIA) slot
- One IEEE 1394 port
- One FIR port
- One RJ-11 modem jack (V.92, 56K)
- One RJ-45 network jack (Ethernet 10/100 Base-T)
- One DC-in jack
- One parallel port (ECP/EPP)
- One S-video port
- One external monitor port
- One microphone-in jack (3.5mm mini jack)
- One headphone jack (3.5mm mini jack)
- Four USB 2.0 ports

System Block Diagram

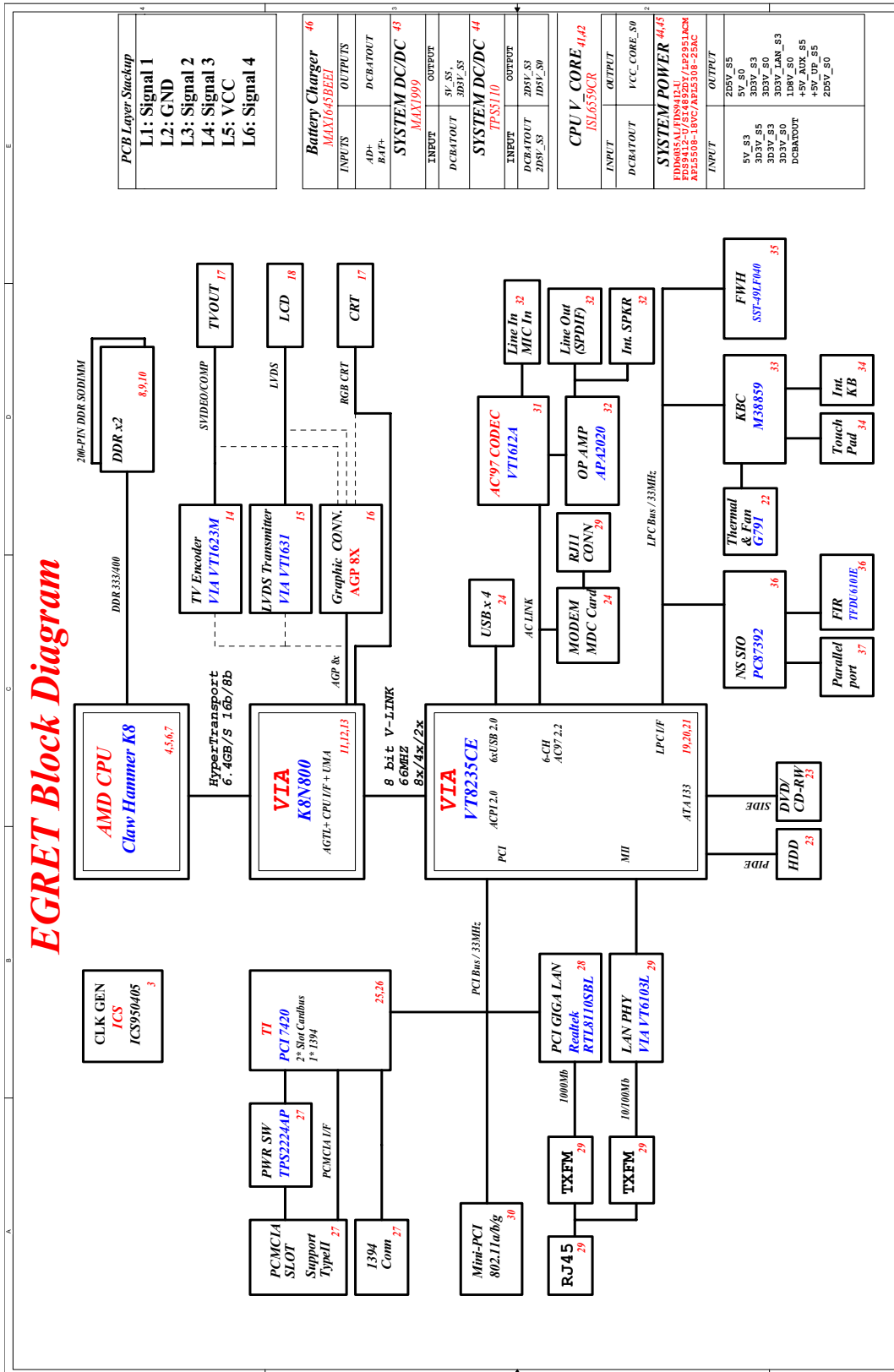

Board Layout

Top View

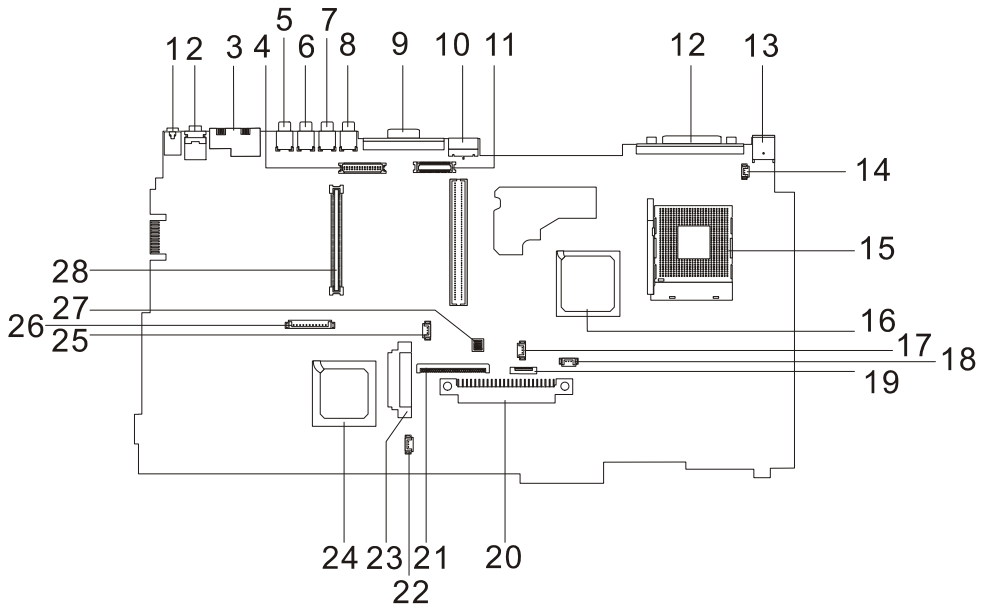

- | | | | |
|----|------------------------------|----|---|
| 1 | Line-in Port | 15 | CPU Socket |
| 2 | Line-out Port | 16 | North Bridge |
| 3 | RJ45+RJ11 | 17 | Fan Connector |
| 4 | LCD Inverter Cable Connector | 18 | Note: There is no 18 on this main board. |
| 5 | USB Port | 19 | Touchpad Cable Connector |
| 6 | USB Port | 20 | HDD Connector |
| 7 | USB Port | 21 | Keyboard Connector |
| 8 | USB Port | 22 | Speaker Cable Connector |
| 9 | VGA Port | 23 | Optical Drive Connector |
| 10 | S-Video Port | 24 | South Bridge |
| 11 | LCD Coaxial Cable Connector | 25 | RTC Battery Connector |
| 12 | Parallel Port | 26 | Launch Board Cable Connector |
| 13 | DC-in Port | 27 | SW1 (Please see Chapter 5 for its settings) |
| 14 | LCD Lid Switch | 28 | PCMCIA Slot |

Bottom View

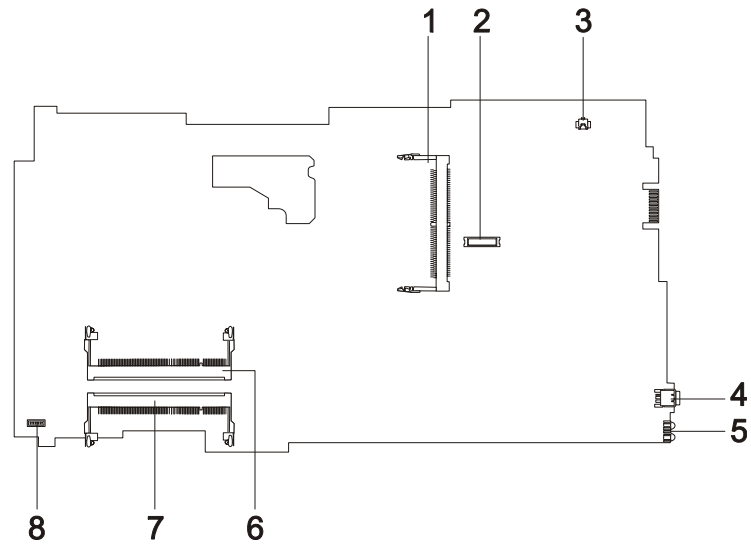

- | | | | |
|---|-----------------------------|---|----------------------------|
| 1 | Wireless LAN Card Connector | 5 | FIR Port |
| 2 | Modem Board Connector | 6 | DIMM Socket 1 |
| 3 | Modem Cable Connector | 7 | DIMM Socket 2 |
| 4 | IEEE 1394 Port | 8 | DC Charger Board Connector |

Panel

Ports allow you to connect peripheral devices to your computer as you would with a desktop PC.

Front View



#	Item	Description
1	Display screen	Liquid-Crystal Display (LCD) provides visual output.
2	Status indicators	LEDs (Light Emitting Diodes) that turn on and off to show the status of the computer and its functions and components.
3	Power button	Turns the computer on and off.
4	Launch Keys	Buttons for launching frequently used programs.
5	Palmrest	Comfortable support area for your hands when you use the computer.
6	Click buttons & 4-way scroll key	The left and right buttons function like the left and right mouse buttons, the center button serves as a scroll up/down button.
7	Touchpad	Touch-sensitive pointing device which functions like a computer mouse.
8	Keyboard	Inputs data into your computer.
9	Ventilation Slot	Enables the computer to stay cool, even after the prolonged use.

Left view

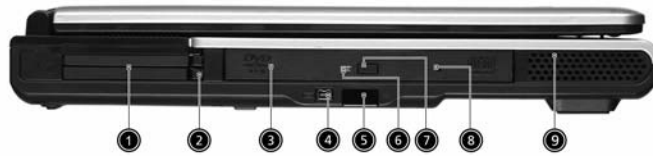

#	Icon	Item/ Port	Description
1		PC Card slots	Supports two Type II or one Type III CardBus PC Card(s).
2		Eject button	Eject PC cards from the card slots.
3		Optical drive	Internal optical drive; accepts CDs or DVDs depending on the optical drive type.
4		IEEE 1394 port	Connects to IEEE 1394 devices.
5		Infrared port	Interfaces with infrared devices (e.g., infrared printer, IR-aware computer).
6		LED indicator	Lights up when the optical drive is active.
7		Eject button	Ejects the optical drive tray from the drive.
8		Emergency eject slot	Ejects the optical drive tray when the computer is turned off. There is a mechanical eject button on the CD-ROM or DVD-ROM drive. Simply insert the tip of a pen or paperclip and push to eject the tray.
9		Speaker	Delivers stereo audio output.

Right View



#	Item/ Port	Description
1	Speaker	Delivers stereo audio output.
2	Ventilation slots	Enable the computer to stay cool, even after prolonged use.
3	Security keylock	Connects to a Kensington-compatible computer security lock.

Rear Panel

1



#	Icon	Port	Description
1		Power Jack	Connects to an AC adapter
2		Parallel port	Connects to a parallel device (e.g., parallel printer)
3		Ventilation slots	Enable the computer to stay cool, even after prolonged use.
4		S-video port	Connects to a television or display device with S-video input.
5		External display port	Connects to a display device (e.g., external monitor, LCD projector).
6		Four USB 2.0 ports	Connects to any Universal Serial Bus devices(e.g., USB mouse, USB camera).
7		Network jack	Connects to an Ethernet LAN network
8		Modem jack	Connects to the phone line
9		Speaker/line-out/ headphone jack	Connects to audio line-out devices (e.g., speakers and headphones).
10		Line-in/mic-in jack	Accepts audio line-in devices (e.g., audio CD player and stereo walkman).

Bottom View



#	Item	Description
1	Battery bay	Houses the computer's battery pack.
2	Battery release latch	Unlatches the battery to remove the battery pack.
3	Memory compartment	Houses the computer's main memory.

Indicators

The computer provides an array of seven indicators located below the display screen, showing the status of the computer and its components.



The Power and Sleep status icons are visible even when you close the display cover so you can see the status of the computer while the cover is closed.

#	Icon	Function	Description
		InviLink	Indicates status of wireless or Bluetooth (optional) communications. Orange--WLAN; Blue--Bluetooth
1		Power	Lights when the computer is on.
2		Sleep	Lights when the computer enters Standby mode and blinks when it enters into or resumes from hibernation mode.
3		Media Activity	Lights when the floppy drive, hard disk or optical drive is active.
4		Battery Charge	Lights when the battery is being charged.
5		Caps Lock	Lights when Caps Lock is activated.
6		Num Lock	Lights when Numeric Lock is activated.

Keyboard





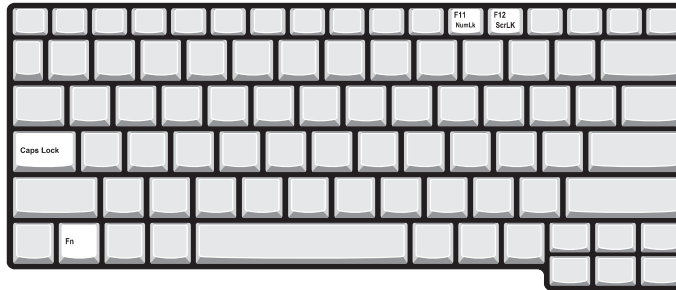

The keyboard has full-sized keys and an embedded keypad, separate cursor keys, two Windows keys and twelve function keys.

Special keys

Lock keys

The keyboard has three lock keys which you can toggle on and off.



Lock key	Description
Caps Lock 	When  is on, all alphabetic characters typed are in uppercase.
Num Lock (Fn-F11) 	When  is on, the embedded keypad is in numeric mode. The keys function as a calculator (complete with the arithmetic operators $\%$, $-$, $*$, and $/$). Use this mode when you need to do a lot of numeric data entry. A better solution would be to connect an external keypad.
Scroll Lock (Fn-F12) 	When  is on, the screen moves one line up or down when you press the up or down arrow keys respectively.  does not work with some applications.

Embedded numeric keypad

The embedded numeric keypad functions like a desktop numeric keypad. It is indicated by small characters located on the upper right corner of the keycaps. To simplify the keyboard legend, cursor-control key symbols are not printed on the keys.











Desired access	Num lock on	Num lock off
Number keys on embedded keypad	Type numbers using embedded keypad in a normal manner.	
Cursor-control keys on embedded keypad	Hold Shift while using cursor-control keys.	Hold Fn while using cursor-control keys.
Main keyboard keys	Hold Fn while typing letters on embedded keypad.	Type the letters in a normal manner.

Windows keys

The keyboard has two keys that perform Windows-specific functions.



Keys	Description
Windows logo key 	Start button. Combinations with this key perform shortcut functions. Below are a few examples:  + Tab (Activates next taskbar button)  + E (Explores My Computer)  + F (Finds Document)  + M (Minimizes All)  +  + M (Undoes Minimize All)  + R (Displays the Run... dialog box)
Application key 	Opens a context menu (same as a right-click).









Hot Keys

The computer employs hot keys or key combinations to access most of the computer's controls like screen contrast and brightness, volume output and the BIOS Utility.

To activate hot keys, press and hold the **Fn** key before pressing the other key in the hot key combination.



Hot Key	Icon	Function	Description
Fn-F1	?	Hotkey help	Displays a list of the hotkeys and their functions.
Fn-F2		Setup	Accesses the notebook configuration utility.
Fn-F3		Power Management Scheme Toggle	Switches the power management scheme used by the computer (function available if supported by operating system).
Fn-F4	Z ^z	Sleep	Puts the computer in Sleep mode.
Fn-F6		Display toggle	Switches display output between the display screen, external monitor (if connected) and both the display screen and external monitor.
Fn-F8		Screen blank	Turns the display screen backlight off to save power. Press any key to return.
Fn-F7		Touchpad toggle	Turns the internal touchpad on and off.
Fn-F8		Speaker toggle	Turns the speakers on and off; mutes the sound.
Fn-↑		Volume up	Increases the sound volume.
Fn-↓		Volume down	Decreases the sound volume.
Fn-→		Brightness up	Increases the screen brightness.

Hot Key	Icon	Function	Description
Fn- 		Brightness down	Decreases the screen brightness.
Fn- 	Pg Up Home	Home	Functions as the  key.
Fn- 	Pg Dn End	End	Functions as the  key.
 Gr-Euro		Euro	Types the Euro symbol.

The Euro symbol

If your keyboard layout is set to United States-International or United Kingdom or if you have a keyboard with a European layout, you can type the Euro symbol on your keyboard.



NOTE: for US keyboard users: The keyboard layout is set when you first set up Windows. For the Euro symbol to work, the keyboard layout has to be set to United States-international.

To verify the keyboard type:

1. Click on **Start, Control Panel**.
2. Double-click on **Regional and Language Options**.
3. Click on the **Language** tab and click on **Details**.
4. Verify that the keyboard layout used for “En English (United States) is set to United States-International. If not, select and click on **ADD**; then select **United States-International** and click on **OK**.
5. Click on **OK**.





To type the Euro symbol:

1. Locate the Euro symbol on your keyboard.
2. Open a text editor or word processor.
3. Hold  Gr and press the Euro symbol.

Launch Keys

Located at the top of the keyboard are six buttons. These buttons are called launch keys. They are designated as mail button, Web browser button, P1, P2, Bluetooth and Wireless buttons. The Wireless and Bluetooth buttons cannot be set by the user. To set the other four launch keys, run the Acer Launch Manager.



#	Icon	Function	Description
1		Mail	Launches email application
2		Web browser	Launches Internet browser application
3		e	User-programmable
4		P	User-programmable
5		Bluetooth (optional)	Enables your Bluetooth
6		Wireless (optional)	Enables your 802.11b/g Wireless LAN.

Hardware Specifications and Configurations

System Board Major Chips

Item	Controller
System core logic	VIA K8N800+VIA VT8235CE
Super I/O controller	NS PC87392
Audio controller	VIA VT1612A
Video controller	NVIDIA® GeForce™ FX Go5200 for Aspire 1360 Series NVIDIA® GeForce™ FX Go5700 for Aspire 1520 Series
Hard disk drive controller	Embedded in VT8235CE
Keyboard controller	Mitsubish LPC keyboard controller M38857
CardBus Controller	TI PCI 7420
RTC	Embedded in VT8235CE
LAN Controller/Chipset	10/100: VIA 6103L; Giga LAN: Realtek 8110SB-32
Memory Controller	Built-in CPU
Bluetooth Controller/Chipset (Does this chipset support voice function??)	
Modem Controller/Chipset	
HDD Controller	Embedded in VT8235CE
ODD Controller	Embedded in VT8235CE
Parallel Port Controller	NS PC87392
USB Controller	Embedded in VT8235CE
PCMCIA Controller	TI PCI 7420

Processor

Item	Specification
CPU type	Mobile AMD Sempron processor 2600+ to 3000+ or higher (for Aspire 1360) AMD Athlon 64 processor 3000+ to 3400+ or higher (for Aspire 1520)
CPU package uOG	uOG 754 pin
CPU core voltage	1.5V
CPU I/O voltage	High speed: 1.2V => for RAM 2.5V Low speed: 1.2V =>for Hypertransport 1.2V

BIOS

Item	Specification
BIOS vendor	Phoenix BIOS
BIOS Version	1.0
BIOS ROM type	Flash ROM
BIOS ROM size	512KB
BIOS package	32 Pin PLCC
Supported protocols	ACPI 2.0, SMBIOS 2.3, PCI 2.3, Boot Block, PXE 2.0, Mobile PC2001, Hard Disk Password, INT 13h Extensions, PCI Bus Power Management interface Specification, EI Torito-Bootable CD-ROM Format Specification V1.0, Simple Boot Flag 1.0
BIOS password control	Set by switch, see SW1 settings on chapter 5

Second Level Cache

Item	Specification
Cache controller	Built-in CPU
Cache size	128KB or 256KB for AMD Sempron CPU 1MB for AMD Athlon 64 DTR CPU
1st level cache control	Always Enabled
2nd level cache control	Always Enabled
Cache scheme control	Fixed-in write back

System Memory

Item	Specification
Memory controller	VIA K8N800
Onboard memory size	0MB
DIMM socket number	2 Sockets
Supports memory size per socket	256/512/1024MB (if available)
Supports maximum memory size	2048MB (Please confirm if 1024MB has passed the test or not)
Supports DIMM type	DDR-DRAM
Supports DIMM Speed	333 MHz
Supports DIMM voltage	2.5 V
Supports DIMM package	200-pin so-DIMM
Memory module combinations	You can install memory modules in any combinations as long as they match the above specifications.

Memory Combinations

Slot 1	Slot 2	Total Memory
0MB	128MB	128 MB
128MB	0MB	128 MB
128MB	128MB	256 MB
256MB	0MB	256MB
0MB	256MB	256MB
256MB	128MB	384MB
128MB	256MB	384MB
256MB	256MB	512MB
0MB	512MB	512MB
512MB	128MB	640MB
256MB	512MB	768MB
128MB	512MB	640MB
512MB	256MB	768MB
256MB	128MB	384MB
512MB	512MB	1024MB

Above table lists some system memory configurations. You may combine DIMMs with various capacities to form other combinations.

LAN Interface

Item	Specification
Chipset	10/100Mbps: VIA 6103L; Giga LAN: 8110SB-32

LAN Interface

Item	Specification
Supports LAN protocol	10/100Mbps for Aspire 1360; 10/100/1000Mbps for Aspire 1520
LAN connector type	RJ45
LAN connector location	Rear side
PXE Version	2.0

Modem Interface

Item	Specification
Chipset	VIA VT8235CE
Fax modem data baud rate (bps)	14.4K
Data modem data baud rate (bps)	56K
Supports modem protocol	V.90/V.92MDC
Modem connector type	RJ11
Modem connector location	Rear side

Hard Disk Drive Interface

Item			
Vendor & Model Name	HGST Moraga IC25N030ATMR04 Fujitsu V-40 MHT2030AT Seagate N1 ST93015A	HGST Moraga IC25N040ATMR04- TOSHIBA Pluto 40G MK4025GAS Fujitsu V40+ MHT2040AT Seagate N1 ST94019A	HGST Moraga IC25N060ATMR04-0 TOSHIBA Neptune MK6021GAS
Capacity (MB)	30000	40000	60000
Bytes per sector	512	512	512
Logical heads	16	16	16
Logical sectors	63	63	63
Drive Format			
Logical cylinders	16383	16383	16383
Physical read/write heads	2/Not show/2	2/Not show/2/2	3/4
Disks	1/Not show/1	1/Not show/1/1	2
Spindle speed (RPM)	4200RPM	4200RPM	4200RPM
Performance Specifications			
Buffer size	2MB	2MB/8MB for Toshiba	2MB/8MB for HGST
Interface	ATA-5 for other vendors /ATA-6 for HGST and Toshiba	ATA-5 for other vendors /ATA-6 for HGST	ATA-5/ATA-6 for HGST
Data transfer rate (disk-buffer, Mbytes/s)	350	350	350
Data transfer, rate (host~buffer, Mbytes/s)	100 MB/Sec	100 MB/Sec	100MB/Sec
DC Power Requirements			
Voltage tolerance	5 +/- 5%	5 +/- 5%	5 +/- 5%

CD-ROM Interface

Items	Specification
Vendor & Model Name	QSI SCR242 Mitsumi SR244W1
Performance Specification	
Burst Data Transfer rate	PIO mode 4: 16.7 MB/sec Max. (Mode 0~4) Multi-word DMA mode 2: 16.7 MB/sec Max. (Mode 0~2) Ultra DMA mode 2: 33.3MB/sec Max.
Access time (typ.)	QSI- Random: 90 ms Full Stroke: 180 ms Mitsumi- Random: 100 ms Full Stroke: 240 ms
Rotation speed	5100 rpm for QSI 5400 rpm for Mitsumi 24X CAV mode
Data Buffer Capacity	128 KB (built-in)
Interface	Compliant to ATA/ATAPI-6
Applicable disc format	QSI: CD-DA, CD-ROM Mode-1, CD-ROM/XA Mode-2, Form-1 and Mode-2 Form-2, CD-i Ready, Video-CD (MPEG-1), Karaoke CD, Photo-CD, Enhanced CD, CD Plus, CD Extra, i-trax CD, CD-Text, CD-R and CD-RW Mitsumi: CD-DA, CD-ROM (Mode 1 and Mode2) CD-ROM XA (Mode 2 Form 1 and Form2), CD-I (Mode2 Form 1 and Form 2), CD-I Bridge (Photo CD, CD EXTRA), Enhanced CD, CD-RW, CD-R, CD-TEXT
Loading mechanism	Drawer with soft eject and emergency eject hole
Power Requirement	
Input Voltage	+5V[DC]±5%

DVD-ROM Interface

Item	Specification	
Vendor & model name	MKE SR-8177	
Performance Specification	With CD Diskette	With DVD Diskette
Transfer rate (KB/sec)	Average Sustained: CAV mode 775~1800 blocks/sec (10.3X to 24X) 1550~3600kBytes/sec (Mode 1) 1768~4106 kBytes/sec (Mode 2)	DVD-5: Normal Speed (1X) 11.08 Mbits/sec CAV mode 36.67~88.64 Mbits/sec DVD-9/DVD-R: Normal Speed (1X) 11.08 Mbits/sec CAV mode 36.67~88.64 Mbits/sec

DVD-ROM Interface

Item	Specification
Average Full Access time (typ.)	Random CAV mode 110 msec typical 150 msec average max Full Stroke CAV mode 200 msec typical 260 msec average max DVD-5: Random 120 msec typical 160 msec average max Full Stroke 270 msec typical 350 msec average max DVD-9: Random 150 msec typical 200 msec average max Full Stroke 340 msec typical 450 msec average max DVD-RAM (2.6G) Random 200 msec typical 300 msec average max Full Stroke 300 msec typical 600 msec average max DVD-RAM (4.7G) Random 180 msec typical 300 msec average max Full Stroke 320 msec typical 700 msec average max
Data Buffer Capacity	512 kBytes
Interface	IDE
Applicable disc format	DVD: DVD-5, DVD-9, DVD-10, DVD-R (3.95G), DVD-RAM (2.6G), DVD-RAM (4.7G) CD: CD-Audio, CD-ROM (mode 1 and mode 2), CD-ROM XA (mode 2, form 1 and form 2), CD-I (mode 2, form 1 and form 2), CD-I Ready, CD-I Bridge, CD-WO, CD-RW, Photo CD, Video CD, Enhanced Music CD, CD-TEXT
Loading mechanism	Soft eject (with emergency eject hole)
Power Requirement	
Input Voltage	+5V[DC]±5%

Combo Drive Interface

Item	Specification
Vendor & model name	KME UJDA750
Performance Specification	

Combo Drive Interface

Item	Specification
Transfer rate (KB/sec)	Read Sustained: DVD-ROM MAX 8X CAV (MAX 10800 KB/sec) CD-ROM MAX 24X CAV (MAX 3600 KB/sec) Write: CD-R 4X, 8X (CLV), Max 16X, MAX 24X (ZCLV) CD-RW 4X (CLV) HS-RW 4X,8X, 10X (CLV) ATAPI Interface: PIO mode 16.6 MB/sec :PIO Mode 4 DMA mode 16.6 MB/sec:Multi word mode 2 Ultra DMA mode 33.3MB/sec: Ultra DMA mode 2
Buffer rate	2MB
Access time	DVD-ROM 180 ms typ. (1/3 stroke) CD-ROM 130 ms typ. (1/3 stroke)
Start up time	less than 15s
Stop time	less than 6s
Acoustic noise	less than 50 dBA
Interface	Enhanced IDE (ATAPI) compatible
Master/Slave	Set by Cable Select (By host)
PC compatible	PC2001 compatible
Applicable disc format	CD: CD-DA, CD-ROM, CD-ROM XA, CD-R, CD-RW, PhotoCD (multiSession), Video CD, CD-Extra(CD+), CD-text DVD: DVD-ROM, DVD-R, DVD-RW (Ver.1.1), DVD-VIDEO, DVD-RAM (2.6GB, 4.7GB)
Slope	15 degree (Any direction)
Dimensions, Weight	128X129X12.7mm (WXDXH) (except protrusion) 200g+- 10g
Eject	Soft Eject (with emergency eject hole)

DVD Dual Interface

Item	Specification
Vendor & model name	Liteon DVD-Dual SDW-431S
Disc type for read/write application	
Applicable Formats	CD-DA, CD-TEXT, CD ROM Mode-1, CD-ROM/XA Mode-2 Form-1 and Form-2, CD-I Ready, Video-CD (MPEG-1), Karaoke-CD, Photo-CD, Enhance CD, CD extra, I-Trax CD and UDF DVD-ROM, DVD-Video, DVD-Audio, DVD-R single/multi border(s) DVD+R single/multi session(s) DVD-RW DVD+RW
Applicable Media Type	CD-ROM, CD-R and CD-RW DVD-ROM (4.7G/8.54G) single layer on single/double side (read only), DVD-ROM dual layer (PTP/OTP) on single/double side (read only) DVD-R (3.9G, 4.7G for General and Authoring), DVD-RW, DVD+RW (4.7G) DVD+R

DVD Dual Interface

Item	Specification
Disc Diameter	12cm and 8cm
Capacity	2048 bytes/sector (DVD) 2048 bytes/block (CD Mode-1 and Mode-2 Form-1) 2336 bytes/block (Mode-2) 2328 bytes/block (Mode-2 Form-2)
Operation environment for "write/rewrite" application	
Host Machine	IBM compatible PC (Pentium 166 MHz or above)
OS	MS-Windows 90/ME/2000/XP/NT 4.0
Memory	Min. 128MB required
Hard Disk	Empty Storage Capacity: 100 MB or more Average access time: 20ms or less
Disc Diameter	12cm and 8cm
Recommended Media	<p>CD-R: AMT, CMC, Csita, Delphi, EverMedia, Imation, LeadData(Silver-Sil), Maxell, MCC (Bagdad), Mirage, Mitsui, MoserBaer(India), MPO, NanYa, Plasmon, Prodisc, RAMedia, Ricoh, Ritek(JS, S, Richodye), SAST (ultra green), SKC(Korea), TDK, TY (DX dye)</p> <p>Low Speed CD-RW: CMC, Daxon, Fonet, Gigastorage, Imation, Infodisc, LeadData, MCC, Nanya, Princo, Prodisc, Ricoh, Ritek</p> <p>High Speed CD-RW: AMT, CMC, Infodisc, Nanya, Postech, Prodisc, Ritek, Ricoh, MCC, SKC(Korea)</p> <p>Ultra Speed CD-RW: Daxon, Imation, Infodisc, MCC, Prodisc, Ritek</p> <p>DVD+R: BEALL, CMC, Daxon, Fuji, HP, Maxell, MCC, Memorex, OPTODISC, PRODISC, Ricoh, RICOH, Ritek, SONY, TDK, TYUDE</p> <p>DVD+RW: CMMC, Daxon, Imation, MCC, Philips, Ricoh, Ritek, Sony</p> <p>DVD-R: BeAll, CMMC, DAXON, DVSN Fornex, GSC, Imation, LeadData, Maxell, Mitsubishi, Nanya, Pioneer, Princo, Prodisc, Ritec, Ritek, SKC, Sony, That's</p> <p>DVD-RW: CMC, Mitsubishi, Princo Ritek</p>
Mechanism	
Pick-up	<p>NA: CD: 0.51 DVD: 0.65</p> <p>Focusing: Astigmatism</p> <p>Tracking: CD: DPP DVD-ROM: DPD DVD+R/RW: DPP</p> <p>Wave length: CD: 785+/- 5 nm DVD: 650+/- 15 nm</p> <p>Output power: Read CD: 1.5 mw max@objective lens DVD: 1.0 mw max Write CD: 65 mw max2@objective lens DVD: 20 mw max</p>
Traverse mechanism	DC Stepping motor driven
Spindle motor	DC burshless motor

DVD Dual Interface

Item	Specification
Loading mechanism	Manual load/DC brushless motor system

Audio Interface

Item	Specification
Audio Controller	VT 1612A
Audio onboard or optional	Built-in
Mono or Stereo	Stereo
Resolution	20 bit stereo Digital to Analog converter 18 bit stereo Analog to Digital converter
Compatibility	Microsoft PC98/PC99, AC97 2.1
Mixed sound source	Line-in, CD, Video, AUX
Voice channel	8/16 bit, mono/stereo
Sampling rate	44.1 KHz
Internal microphone	Yes
Internal speaker / Quantity	Yes/2
Supports PnP DMA channel	DMA channel 0 DMA channel 1
Supports PnP IRQ	IRQ10

Video Interface

Item	Specification
Vendor & Model Name	Integrated Uni Chrome Pro IGP with up to 64MB shared video RAM (for Aspire 1360/1520) NVIDIA® GeForce™ FX Go5200 (for Aspire 1360, manufacturing option) NVIDIA® GeForce™ FX Go5700 (for Aspire 1520, manufacturing option)
Chip voltage	N/A
Supports ZV (Zoomed Video) port	NO
Graph interface	8X AGP (Accelerated Graphic Port) Bus
Maximum resolution (LCD)	1024 x768 (32bit colors)
Maximum resolution (CRT)	1600x1200 (32 bit colors)

VGA Display Resolution

Display device	Source image in the frame buffer					
	640x480	800x600	1024x768	1280x1024	1400x1050	1600x1200
800x600 LCD	Expanded	True image	Partial image	Partial image	Partial image	Partial image
1024x768 LCD	Expanded	Expanded	True image	Partial image	Partial image	Partial image
1280x1024 LCD	Expanded	Expanded	Expanded	True image	Partial image	Partial image
1400x1050 LCD	Expanded	Expanded	Expanded	Expanded	True image	Partial image
1600x1200 LCD	Expanded	Expanded	Expanded	Expanded	Centered	True image
640x480 CRT	True image	Partial image	Partial image	Partial image	Partial image	Partial image
800x600 CRT	True image	True image	Partial image	Partial image	Partial image	Partial image
1024x768 CRT	True image	True image	True image	Partial image	Partial image	Partial image
1280x1024 CRT	True image	True image	True image	True image	Partial image	Partial image

VGA Display Resolution

Display device	Source image in the frame buffer					
	640x480	800x600	1024x768	1280x1024	1400x1050	1600x1200
1600x1200 CRT	True image	True image	True image	True image	True image	True image

Video Memory

Item	Specification
Fixed or upgradeable	Fixed for UMA upgradeable for NVIDIA® GeForce™ FX Go5200/5700
Video memory size	64MB

LCD Display Resolution

Resolution	8 bit (256colors)	16 bits (Hi color)	24 bits (True color)	32 bits (True color)
640x480	Yes	Yes	Yes	Yes
720x480	Yes	Yes	Yes	Yes
800x600	Yes	Yes	Yes	Yes
848x480	Yes	Yes	Yes	Yes
1024x768	Yes	Yes	Yes	Yes

CRT Display Resolutions

Resolution	8 bit (256colors)	16 bits (Hi color)	24 bits (True color)	32 bits (True color)
640x480	Yes	Yes	Yes	Yes
720x480	Yes	Yes	Yes	Yes
800x600	Yes	Yes	Yes	Yes
848x480	Yes	Yes	Yes	Yes
1024x768	Yes	Yes	Yes	Yes
1152x864	Yes	Yes	Yes	Yes
1280x1024	Yes	Yes	Yes	Yes
1400x1050	Yes	Yes	Yes	Yes
1600x1200	Yes	Yes	Yes	Yes

Parallel Port

Item	Specification
Parallel port controller	NS PC87392
Number of parallel port	1
Location	Rear side
Connector type	25-pin D-type
Parallel port function control	Enable/Disable by BIOS Setup
Supports ECP/EPP	Yes (set by BIOS setup)
Optional ECP DMA channel (in BIOS Setup)	DMA channel 1 and 3
Optional parallel port I/O address (in BIOS Setup)	378, 278

Parallel Port

Item	Specification
Optional parallel port IRQ (in BIOS Setup)	IRQ5, IRQ7

USB Port

Item	Specification
USB Compliancy Level	1.1/2.0 support
OHCI	USB 2.0
Number of USB port	4 5V/500 mA per slot
Location	Rear side
Other Remarks	3 independent OHCI USB1.1 Host Controller and 1 EHCI USN2.0 Host Controller.

PCMCIA Port

Item	Specification
PCMCIA controller	TI PCI 7420
Supports card type	Type II, Tpye III
Number of slots	Two type II, one type III
Access location	Left side
Supports ZV (Zoomed Video) port	Yes
Supports 32 bit CardBus	Yes (IRQ17)

Keyboard

Item	Specification
Keyboard controller	Mitsubishi LPC keyboard controller M38857
Keyboard vendor & model name	Darfon/Sunrex
Total number of keypads	84-/85-/88-key
Windows keys	Yes
Internal & external keyboard work simultaneously	Yes

Battery

Item	Specification
Vendor & model name	Normal: Sanyo/Simplo; Highrate: Sanyo/Sony
Battery Type	Li-ION
Pack capacity	2000mAH
Number of battery cell	8
Package configuration	4 serial 2 parallel
Output voltage	14.4Vdc (nominal)

LCD

Item			
Vendor & model name	LCD 15.4" WXGA QDI	LCD 15.4" WXGA AU B154EW01	LCD 15.4" WXGA HITACHI

LCD

Item			
Screen Diagonal (mm)	390.1	391	391
Active Area (mm)	331.2x207.0	331.2x207.0	331.2x207.0
Display resolution (pixels)	1280x800 WXGA	1280x800 WXGA	1280x800 WXGA
Pixel Pitch	0.2588x0.2588	0.2588x0.2588	0.25875x0.25875
Pixel Arrangement	R.G.B. Vertical Stripe	R.G.B. Vertical Stripe	R.G.B. Vertical Stripe
Display Mode	Normally White	Normally White	Normally White
Typical White Luminance (cd/m ²) also called Brightness	185	195 min (5 point average) 220 Typ. (5 point average)	185
Luminance Uniformity	1.4 (5pts)	1.25 max. (5pts) 1.50 max. (13pts)	N/A
Contrast Ratio	400	400	200
Response Time (Optical Rise Time/Fall Time)	5/20	18/7	30/20
Nominal Input Voltage VDD	+3.3V Typ.	+3.3V Typ.	+3.3V Typ.
Typical Power Consumption (watt)	4.38	6.5	N/A
Weight	585	580	620
Physical Size(mm)	344x222.0x6.35 max	344x222.0x6.5 max	344.5x222.5x6.5 max
Electrical Interface	1 channel LVDS	1 channel LVDS	1 channel LVDS
Support Color	262K colors (RGB 6-bit data driver)	262K colors (RGB 6-bit data driver)	262K colors (RGB 6-bit data driver)
Viewing Angle (degree) Horizontal: Right/Left Vertical: Upper/Lower	15/35 45/45	70/70 60/60	60/60 35/65
Temperature Range(° C) Operating Storage (shipping)	0 to +50 -25 to +60	0 to +50 -20 to +60	0 to +50 -20 to +60

AC Adapter

Item	Specification
Vendor & model name	Liteon, 135W power supply
Input Voltage	
Low Range	90(min.)/137(max.)/100-127(nominal)
High Range	180(min.)/265(max.)/200-240(nominal)
Input current	2.2A(max)
Nominal frequency (Hz)	50-60
Frequency variation range (Hz)	47-63
Efficiency	It should provide an efficiency of 85% minimum, when measured at maximum load under 115Vac.
Output Requirements	
DC output voltage	19V
Noise + Ripple	380mV as output voltage is 19V
Peak Load	18.5V-19.71V
Dynamic Output Characteristics	
Turn-on delay time	5 sec (@ 115Vac)
Hold up time	5ms (@115Vac, Full load)

AC Adapter

Item	Specification
Over Voltage Protection (OVP)	29V
Short circuit protection	9.5A @19V output voltage
Electrostatic discharge (ESD)	15KV (at air discharge) 8KV (at contact discharge)
Dielectric Withstand Voltage	
Primary to secondary	2150VDC for 1 sec.
Ground leakage current	less than 250uA

Power Management

Power Saving Mode	Phenomenon
Standby Mode Enter Standby Mode when 1. Standby/Hibernation hot-key is pressed and system is not ready to enter Hibernation mode. 2. System standby/ Hibernation timer expires and system is not ready to enter Hibernation mode.	<input type="checkbox"/> The buzzer beeps <input type="checkbox"/> The Sleep indicator lights up
Hibernation Mode Enter Hibernation Mode (suspend to HDD) when 1. Hibernation hot-key is pressed and system is ready to enter Hibernation mode 2. System Hibernation timer expires and system is ready to enter Hibernation mode.	<input type="checkbox"/> All power shuts off
Display Standby Mode Keyboard, built-in touchpad, and an external PS/2 pointing device are idle for a specified period.	<input type="checkbox"/> The display shuts off
Hard Disk Standby Mode Hard disk is idle within a specified period of time.	<input type="checkbox"/> Hard disk drive is in standby mode. (spindle turned-off)

Environmental Requirements

Item	Specification
Temperature	
Operating	+5~+35 °C
Non-operating	-20~+60 °C
Humidity	
Operating	10% to 95% RH, non-condensing without disktte 10% to 80% RH, non-condensing with disktte
Non-operating	20% to 80% RH, non-condensing (Unpacked)
Non-operating	20% to 90% RH, non-condensing (Storage package)
Vibration	
Operating	5~250Hz 0.5Grms, 15mins per axis
Non-operating (unpacked)	1.04 Grms, 2-200Hz 15 mins per axis
Non-operating (packed)	1.04 Grms, 2-200Hz 15 mins per axis

Mechanical Specification

Item	Specification
Dimensions	361(W) x 292.5(D) x 47.3(H)mm
Weight	3.6kg (8lbs)
I/O Ports	Two Type II or one Type III PC CardBus (PCMCIA) slot One IEEE 1394 port One FIR port One RJ-11 modem jack (V.92, 56K) One RJ-45 network jack One DC-in jack One parallel port (ECP/EPP) One S-video port One external monitor port One microphone-in jack (3.5mm mini jack) One headphone jack (3.5mm mini jack) Four USB 2.0 ports
Drive Bays	One
Material	Plastic
Indicators	Wireless Communication, Power, Sleep, Media Activity, Battery Charge, Caps Lock and NumLock
Switch	Power

System Utilities

BIOS Setup Utility

The BIOS Setup Utility is a hardware configuration program built into your computer's BIOS (Basic Input/Output System).

Your computer is already properly configured and optimized, and you do not need to run this utility. However, if you encounter configuration problems, you may need to run Setup. Please also refer to Chapter 4 Troubleshooting when problem arises.

To activate the BIOS Utility, press **F2** during POST (when "Press <F2> to enter Setup" message is prompted on the bottom of screen).

Press **F2** to enter setup. The default parameter of F12 Boot Menu is set to "disabled". If you want to change boot device without entering BIOS Setup Utility, please set the parameter to "enabled".

Press <F12> during POST to enter multi-boot menu. In this menu, user can change boot device without entering BIOS SETUP Utility.

PhoenixBIOS Setup Utility					
Info.	Main	Advanced	Security	Boot	Exit
CPU Type : Mobile AMD Sempron (TM) Processor 2800+ CPU Speed : 1.6 GHz HDD Model Name : HTS4244040N9AT00-(PM) HDD Serial Number : MPA201Q2G0W2YA ATAPI Model Name : MATSHITADVD-RAM UJ-825S ATAPI Serial Number : None System BIOS Ver : V1.0 VGA BIOS Ver : 90.F8.00.37 KBC Ver : 02.13.29 Serial Number : xxxxxxxxxxxxxxxxxxxxxxxx 22 Byte Asset Tag Number : N/A 32 Byte Produce Name : Aspire 1360 16 Byte Manufacturer Name: Acer 16 Byte UUID: xxxxxxxxxxxxxxxxxxxxxxxx 32 Byte					
F1 Help	↑↓ Select Item	F5/F6 Change Values	F9 Setup Defaults		
Esc Exit	←→ Select Menu	Enter Select	▶ Sub-Menu	F10 Save and Exit	

Navigating the BIOS Utility

There are six menu options: Info., Main, System Devices, Security, Boot, and Exit.

Follow these instructions:

- To choose a menu, use the cursor left/right keys (← →).
- To choose a parameter, use the cursor up/down keys (↑ ↓).
- To change the value of a parameter, press F8 or F6.
- A plus sign (+) indicates the item has sub-items. Press ENTER to expand this item.
- Press ESC while you are in any of the menu options to go to the Exit menu.
- In any menu, you can load default settings by pressing F8. You can also press F6 to save any changes made and exit the BIOS Setup Utility.

NOTE: You can change the value of a parameter if it is enclosed in square brackets. Navigation keys for a particular menu are shown on the bottom of the screen. Help for parameters are found in the Item Specific Help part of the screen. Read this carefully when making changes to parameter values.

This menu provides you the information of the system.

Information

PhoenixBIOS Setup Utility

Info.	Main	Advanced	Security	Boot	Exit
-------	------	----------	----------	------	------

```

CPU Type :           Mobile AMD Sempron (TM) Processor 2800+
CPU Speed :          1.6 GHz
HDD Model Name :     HTS4244040N9AT00-(PM)
HDD Serial Number :  MPA201Q2G0W2YA
ATAPI Model Name :   MATSHITADVD-RAM UJ-825S
ATAPI Serial Number None
System BIOS Ver      V1.0
VGA BIOS Ver         90.F8.00.37
KBC Ver              02.13.29
Serial Number        xxxxxxxxxxxxxxxxxxxxxxxx          22 Byte
Asset Tag Number     N/A                          32 Byte
Produce Name         Aspire 1360                    16 Byte
Manufacturer Name:   Acer                          16 Byte
UUID:                xxxxxxxxxxxxxxxxxxxxxxxxxxxx          32 Byte
                    
```

F1 Help	↑↓ Select Item	F5/F6 Change Values	F9 Setup Defaults
Esc Exit	←→ Select Menu	Enter Select	▶ Sub-Menu F10 Save and Exit

NOTE: The system information is subject to different models.

Parameter	Description
CPU Type	Displays the CPU type information.
CPU Speed	Displays the CPU speed.
HDD Model Name	HDD device model name information will be retrieved automatically during system boot.
HDD Serial Number	HDD device serial number information will be retrieved automatically during system boot.
ATAPI Model Name	Display the ATAPI device model name.
ATAPI Serial Number	Display the ATAPI device serial number
System BIOS Ver	Displays the system BIOS version.
VGA BIOS Ver	Displays the VGA BIOS version.
KBC Ver	Displays the keyboard controller firmware version.
Serial Number	Displays the system serial number.
Asset Tag Number	N/A
Product Name	Displays the product name.
Manufacturer Name	Displays the Acer company.
UUID Number	Displays the UUID (Universal Unique Identifier) string = 32 bytes.

Main

The Main screen displays a summary of your computer hardware information, and also includes basic setup parameters. It allows the user to specify standard IBM PC AT system parameters.

PhoenixBIOS Setup Utility					
Info.	Main	Advanced	Security	Boot	Exit
					Item Specific Help
System Time:	[15:56:48]				<Tab>, <Shift-Tab>, or <Enter> selects field.
System Date:	[08/23/2004]				
System Memory:	640 KB	Shows system base memory size			
Extended Memory:	446MB	Shows extended memory size			
Video Memory	[64 MB]	VGA memory size			
Quiet Boot:	[Enabled]				
Power on Display:	[Auto]				
LCD Auto Dim	[Enabled]				
Network Boot	[Enabled]				
F12 Boot Menu:	[Disabled]				
D2D Recovery	[Enabled]				
F1 Help	↑↓ Select Item	F5/F6 Change Values	F9 Setup Defaults		
Esc Exit	←→ Select Menu	Enter Select	▶ Sub-Menu	F10 Save and Exit	

NOTE: The screen above is for reference only. Actual values may differ.

The table below describes the parameters in this screen. Settings in **boldface** are the default and suggested parameter settings.

Parameter	Description	Format/Option
System Time	Sets the system time. The hours are displayed with 24-hour format.	Format: HH:MM:SS (hour:minute:second) System Time
System Date	Sets the system date.	Format MM/DD/YYYY (month/day/year) System Date
System Memory	This field reports the memory size of the system. Memory size is fixed to 640MB	
Extended Memory	This field reports the memory size of the extended memory in the system. Extended Memory size=Total memory size-1MB	
VGA Memory	Shows the VGA memory size. VGA Memory size=64/128MB	
Fast Boot	Determines if Customer Logo will be displayed or not; shows Summary Screen is disabled or enabled. Enabled: Customer Logo is displayed, and Summary Screen is disabled. Disabled: Customer Logo is not displayed, and Summary Screen is enabled.	Option: Enabled or Disabled
Power on display	Auto: During power process, the system will detect if any display device is connected on external video port. If any external display device is connected, the power on display will be in CRT (or projector) only mode. Otherwise it will be in LCD only mode. Both: Simultaneously enable both the integrated LCD screen and the system's external video port (for an external CRT or projector).	Option: Auto or Both
LCD Auto Dim	Determines if the system will automatically dim the LCD brightness in order to save power when AC is not present. The system will support an automatic dimming of the LCD backlight when the AC power is NOT available (running on battery power).	Option: Enabled or Disabled
Network Boot	Enables, disables the system boot from LAN (remote server).	Option: Enabled or Disabled
F12 Boot Menu	Enables, disables Boot Menu during POST.	Option: Disabled or Enabled
D2D Recovery	Enables or disables Hard Disk to Hard Disk system Recovery by pressing Fn+F10 key during POST.	Option: Enabled or Disabled

NOTE: The sub-items under each device will not be shown if the device control is set to disable or auto. This is because the user is not allowed to control the settings in these cases.

Advanced

The Advanced menu screen contains parameters involving your hardware devices. It also provides advanced settings of the system.

PhoenixBIOS Setup Utility					
Info.	Main	Advanced	Security	Boot	Exit
Infrared Port (FIR)		[Enabled]	Item Specific Help		
Base I/O address:		[2F8]	Configure Infrared Port using options: [Disable] No configuration [Enabled] User configuration [Auto] BIOS or OS chooses configuration (OS Controlled) Displayed when controlled by OS		
Interrupt:		[IRQ 3]			
DMA channel:		[DMA 1]			
Parallel port:		[Auto]			
Mode:		[ECP]			
Base I/O address:		[378]			
Interrupt:		[IRQ 7]			
DMA channel:		[DMA 3]			
Infrared Port (FIR):		[Enabled]			
F1 Help ↑↓ Select Item F5/F6 Change Values F9 Setup Defaults Esc Exit ←→ Select Menu Enter Select ▶ Sub-Menu F10 Save and Exit					

The table below describes the parameters in the screen. Settings in **boldface** are the default and suggested parameter settings.

Parameter	Description	Options
Infrared Port	Enables, disables or auto detects the infrared port.	Enabled /Disabled/Auto
Base I/O address	Sets the I/O address of the infrared port.	2F8 /3F8/3E8/2E8
Interrupt	Sets the interrupt request of the parallel port.	IRQ3 /IRQ4
DMA channel	Sets a DMA channel for the infrared port.	DMA /DMA3
Parallel Port	Enables, disables or auto detects the parallel port.	Enabled /Disabled/Auto
Mode	Sets the operation mode of the parallel port.	ECP , EPP, Output only or Bi-directional
Base I/O address	Sets the I/O address of the parallel port.	378 /278
Interrupt	Sets the interrupt request of the parallel port.	IRQ7 /IRQ5

Parameter	Description	Options
DMA channel	Sets a DMA channel for the printer to operate in ECP mode. This parameter is enabled only if Mode is set to ECP.	DMA3/DMA1
Legacy USB Support	Enables, disables USB interface devices support. (Enable for use with a non-USB aware Operating System such as DOS or UNIX).	Option: Disabled or Enabled

Security

The Security screen contains parameters that help safeguard and protect your computer from unauthorized use.

PhoenixBIOS Setup Utility					
Info.	Main	Advanced	Security	Boot	Exit
					Item Specific Help
User Password is :		Clear		Supervisor Password controls accesses of the whole setup utility. It can be used to boot up when Password on boot is enabled.	
Supervisor Password is :		Clear			
Set User Password		[Enter]			
Set Supervisor Password		[Enter]			
Primary HardDisk Security		[Disabled]			
Password on Boot		[Disabled]			
F1 Help	↑↓ Select Item	F5/F6 Change Values	F9 Setup Defaults		
Esc Exit	←→ Select Menu	Enter Select	▶ Sub-Menu	F10 Save and Exit	

If the current password entered does not match the actual current password, the screen will show you the Setup Warning.

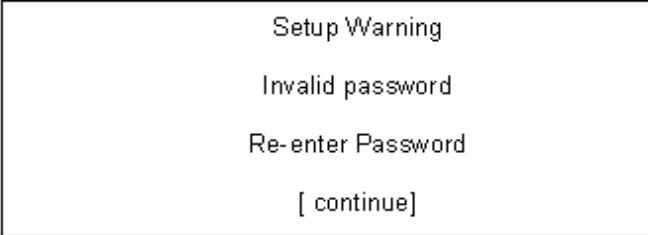

Setup Warning
Invalid password
Re-enter Password
[continue]

A rectangular dialog box with a black border containing four lines of text centered horizontally.

If the new password and confirm new password strings do not match, the screen will display the following message.

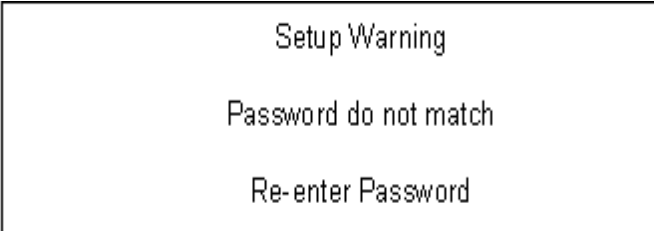

Setup Warning
Password do not match
Re-enter Password

A rectangular dialog box with a black border containing three lines of text centered horizontally.

Boot

This menu allows the user to decide the order of boot devices to load the operating system. Bootable devices includes the distette drive in module bay, the onboard hard disk drive and the CD-ROM in module bay.

PhoenixBIOS Setup Utility					
Info.	Main	Advanced	Security	Boot	Exit
+Hard Drive Floppy Drive CD-ROM/DVD Drive Network Boot				Item Specific Help	
				Use <↑> or <↓> to select a device, then press <F6> to move it up the list, or <F5> move it down the list. Press <ESC> to escape the menu	
F1 Help	↑↓ Select Item	F5/F6 Change Values	F9 Setup Defaults		
Esc Exit	←→ Select Menu	Enter Select	▶ Sub-Menu	F10 Save and Exit	

Exit

The Exit screen contains parameters that help safeguard and protect your computer from unauthorized use.

PhoenixBIOS Setup Utility					
Info.	Main	Advanced	Security	Boot	Exit
Exit Saving Changes Exit Discarding Changes Load Setup Defaults Discard Changes Save Changes					Item Specific Help Exit System Setup and save your changes to CMOS.
F1 Help	↑↓ Select Item	F5/F6 Change Values	F9 Setup Defaults		
Esc Exit	←→ Select Menu	Enter Select	Sub-Menu	F10 Save and Exit	

The table below describes the parameters in this screen.

Parameter	Description
Exit Saving Changes	Exit System Setup and save your changes to CMOS.
Exit Discarding Changes	Exit utility without saving setup data to CMOS.
Load Setup Default	Load default values for all SETUP item.
Discard Changes	Load previous values from CMOS for all SETUP items.
Save Changes	Save Setup Data to CMOS.

BIOS Flash Utility

The BIOS flash memory update is required for the following conditions:

- New versions of system programs
- New features or options
- Restore a BIOS when it becomes corrupted.

Use the Phlash utility to update the system BIOS flash ROM.

NOTE: If you do not have a crisis recovery diskette at hand, then you should create a **Crisis Recovery Diskette** before you use the Phlash utility.

NOTE: Do not install memory-related drivers (XMS, EMS, DPMS) when you use the Phlash.

NOTE: Please use the AC adaptor power supply when you run the Phlash utility. If the battery pack does not contain enough power to finish BIOS flash, you may not boot the system because the BIOS is not completely loaded.

Follow the steps below to run the Phlash.

1. Prepare a bootable diskette.
2. Copy the Phlash utilities to the bootable diskette.
3. Then boot the system from the bootable diskette. The Phlash utility has auto-execution function.

Machine Disassembly and Replacement

This chapter contains step-by-step procedures on how to disassemble the notebook computer for maintenance and troubleshooting.

To disassemble the computer, you need the following tools:

- Wrist grounding strap and conductive mat for preventing electrostatic discharge
- Flat-bladed screw driver
- Phillips screw driver
- Tweezers
- Plastic Flat-bladed screw driver
- Hexed Screw Driver

NOTE: The screws for the different components vary in size. During the disassembly process, group the screws with the corresponding components to avoid mismatch when putting back the components.

NOTE: This chapter has been revised from previous model (TravelMate 240/250). Please refer to the disassembling *procedures* instead of the *images*. Some of the images below contain the parts used in TravelMate 240/250, but not in Aspire 1360/1520.

General Information

Before You Begin

Before proceeding with the disassembly procedure, make sure that you do the following:

1. Turn off the power to the system and all peripherals.
2. Unplug the AC adapter and all power and signal cables from the system.

Disassembly Procedure Flowchart

The flowchart on the succeeding page gives you a graphic representation on the entire disassembly sequence and instructs you on the components that need to be removed during servicing. For example, if you want to remove the main board, you must first remove the keyboard, then disassemble the inside assembly frame in that order.

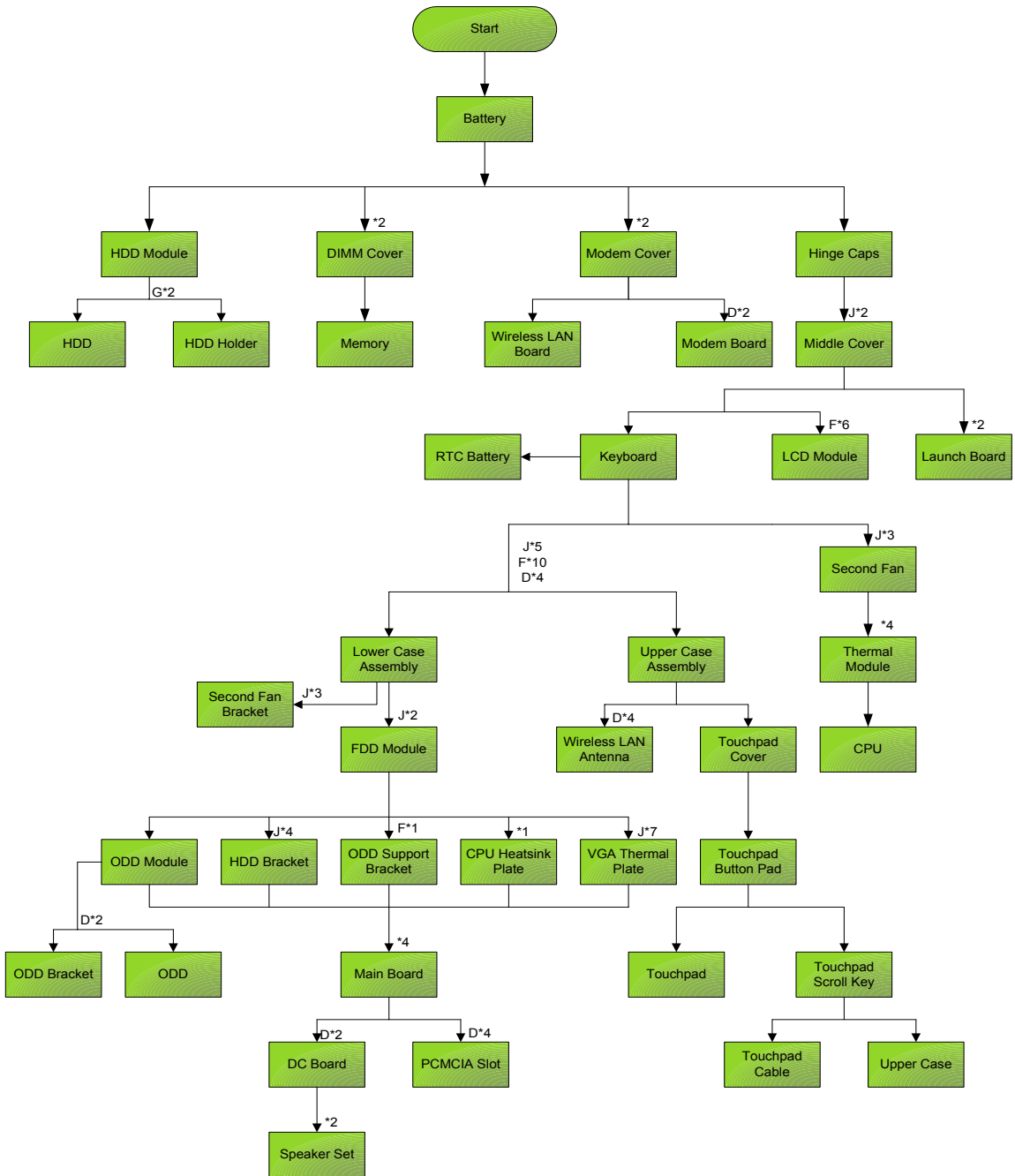

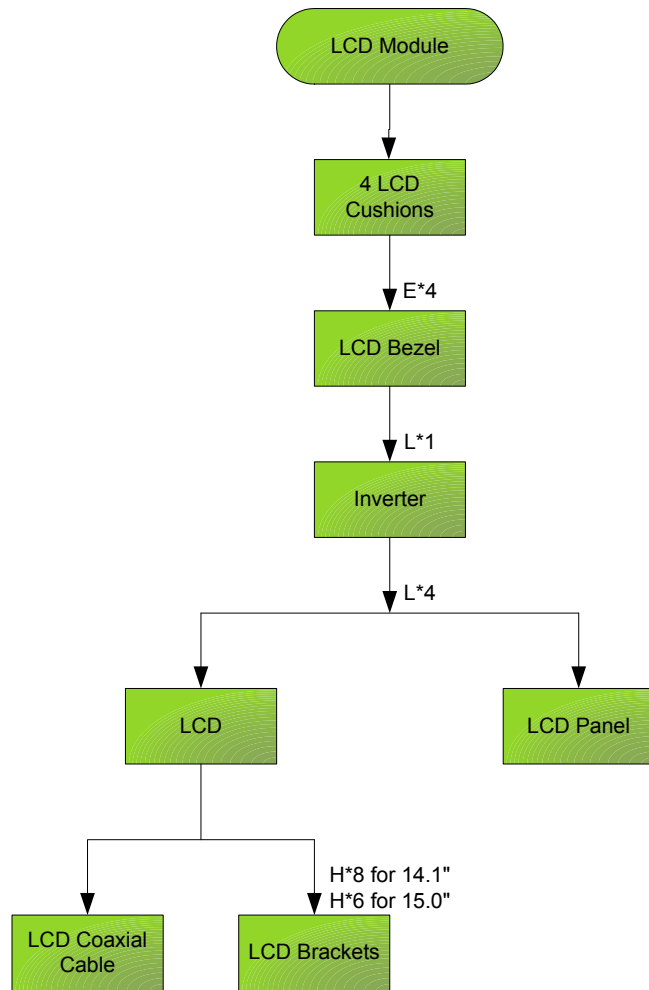

Screw List

Item	Description
A	SCREW MAC FLAT M2.5*L4 NI NYLOK (86.00123.630)
B	SCREW M2.0*L10 NYLOK(86.9A352.100)
C	SCREW M2*3 NYLON 1JMCPC-420325(86.9A352.3R0)
D	SCREW M2.5X6(86.9A353.6R0)
E	SCREW M3x4 (86.9A524.4R0)
F	SCREW M2X2.0 (86.9A552.2R0)
G	SCREW WAFER NYLOK NI 2ML3 (86.9A552.3R0)
H	SCRW M2*4 WAFER NI (86.9A552.4R0)
I	SCRW M2.5*3 WAFER NI (86.9A553.3R0)
J	SCREW M2.5*4L NI (86.9A553.4R0)

Removing the Battery

1. To remove the battery, push the battery release latch.
2. Then slide the battery out from the machine.



Removing the Memory Module

1. See “Removing the Battery” on page 50.
2. To remove the memory module from the machine, first remove the two screws holding the dimm cover.



3. Remove the dimm cover.



4. Pop up the memory.
5. Then remove the memory.



Removing the Wireless LAN Board and the Modem Board

1. See “Removing the Battery” on page 50.
2. To remove the wireless LAN board, first remove the two screws holding the modem cover.



3. Remove the modem cover from the machine.
4. Disconnect the wireless antennae.



5. Pop out the wireless LAN board.
6. To remove the modem board, first remove the two screws fastening the modem board.



7. Detach the modem board and disconnect the modem cable carefully, then remove the modem board.



Removing the Hard Disk Drive Module

1. See “Removing the Battery” on page 50.
2. To remove the hard disk drive, pull the hard disk drive carefully.



3. Then take the hard disk drive out of the main unit.

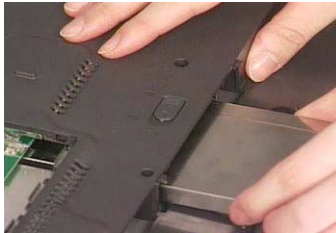

Disassembling the Hard Disk Drive Module

1. See “Removing the Battery” on page 50.
2. See “Removing the Hard Disk Drive Module” on page 53.
3. Remove the two screws that fasten the HDD holder.



4. Detach the hard disk drive from the HDD holder.



Removing the LCD Module

Removing the Middle Cover

1. See “Removing the Battery” on page 50.
2. To remove the middle cover, first use a plastic flat screwdriver to detach the right hinge cap. If you do not have a plastic flat screwdriver, you can simply detach the right hinge cover as the image shows. There is no screw fastening the right hinge cap to the main unit. Please just detach it.
3. Detach the left hinge cap.

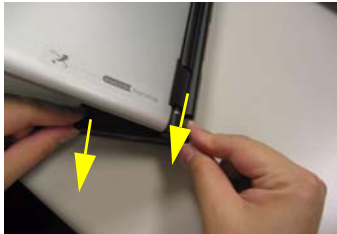

4. Remove the two screws holding the middle cover.
5. Then detach the middle cover from the machine.



6. Turn over the middle cover then disconnect the launch board cable. Then remove the middle cover.

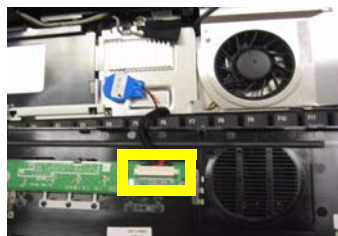

Removing the Launch Board

1. See “Removing the Battery” on page 50.
2. See “Removing the Middle Cover” on page 54.
3. Remove the two screws that secure the launch board to the middle cover. Then detach the launch board from the middle cover.



Removing the LCD Module

1. See “Removing the Battery” on page 50.
2. See “Removing the Middle Cover” on page 54.
3. See “Removing the Launch Board” on page 54.
4. Remove the screw that fastens the LCD coaxial cable and disconnect the cable. Then disconnect the LCD inverter cable. Then pull out the wireless antennae from the main unit carefully.



5. Remove the four screws holding the LCD hinge; two on the right and two on the left. Remove the four screws holding the LCD hinge; two on the right and two on the left.



6. Remove the two screws on the bottom; one on the right and the other on the left.



7. Then you can remove the entire LCD module from the main unit.

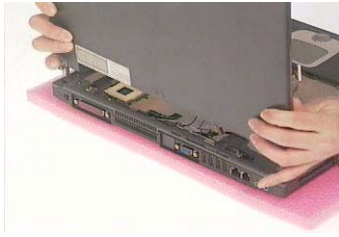

Disassembling the LCD Module

Removing the LCD Bezel

1. See “Removing the Battery” on page 50.
2. See “Removing the Middle Cover” on page 54.
3. See “Removing the Launch Board” on page 54.
4. See “Removing the LCD Module” on page 55.
5. Use plastic tweezers to remove the four screw pads, and then remove the four screws that fasten the LCD bezel.

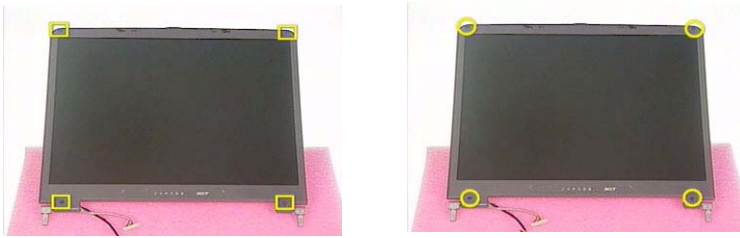

6. Snap off the bezel carefully, and then remove the LCD bezel from the LCD module.



Removing the Inverter Board (15" LCD)

1. See “Removing the Battery” on page 50.
2. See “Removing the Middle Cover” on page 54.
3. See “Removing the Launch Board” on page 54.
4. See “Removing the LCD Module” on page 55.
5. See “Removing the LCD Bezel” on page 57.
6. To remove the inverter board, first remove one screw from the inverter board.

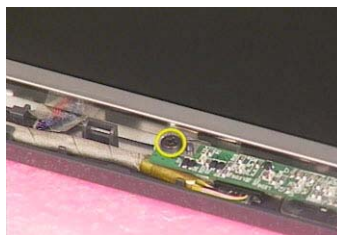

7. Disconnect the LCD power cable then disconnect the inverter cable from the inverter board.



NOTE: Please arrange the LCD inverter cable well to the LCD panel as the picture below shows when you reassemble the LCD module.

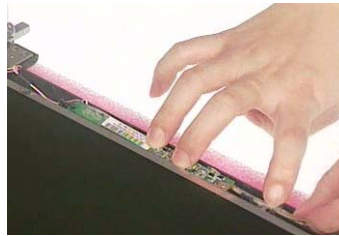

Removing the 15" TFT LCD

1. See "Removing the Battery" on page 50.
2. See "Removing the Middle Cover" on page 54.
3. See "Removing the Launch Board" on page 54.
4. See "Removing the LCD Module" on page 55.
5. See "Removing the LCD Bezel" on page 57.
6. See "Removing the Inverter Board (15" LCD)" on page 57.
7. To remove the LCD, first remove the four screws that secure the LCD hinges.



8. Then take the LCD out of the LCD panel.



Removing the LCD Brackets

1. See “Removing the Battery” on page 50.
2. See “Removing the Middle Cover” on page 54.
3. See “Removing the Launch Board” on page 54.
4. See “Removing the LCD Module” on page 55.
5. See “Removing the LCD Bezel” on page 57.
6. See “Removing the Inverter Board (15” LCD)” on page 57.
7. See “Removing the 15” TFT LCD” on page 58.
8. Remove the four screws holding the right LCD bracket. Then remove the right bracket.

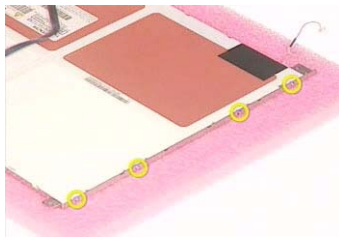

9. Remove the four screws holding the left LCD bracket. Then remove the left bracket..

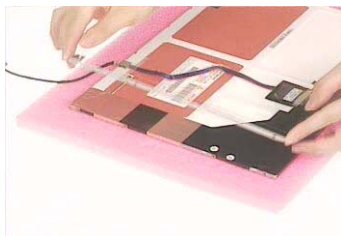
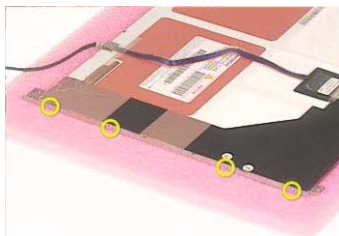

Removing the LCD Coaxial Cable

1. See “Removing the Battery” on page 50.
2. See “Removing the Middle Cover” on page 54.
3. See “Removing the Launch Board” on page 54.
4. See “Removing the LCD Module” on page 55.
5. See “Removing the LCD Bezel” on page 57.
6. See “Removing the Inverter Board (15” LCD)” on page 57.
7. See “Removing the 15” TFT LCD” on page 58.
8. Tear off the mylar fastening the LCD coaxial cable, then disconnect the coaxial cable.



Removing the LCD Hinges

1. See “Removing the Battery” on page 50.
2. See “Removing the Middle Cover” on page 54.
3. See “Removing the Launch Board” on page 54.
4. See “Removing the LCD Module” on page 55.
5. See “Removing the LCD Bezel” on page 57.
6. See “Removing the Inverter Board (15” LCD)” on page 57.
7. See “Removing the 15” TFT LCD” on page 58.
8. Remove the screw holding the right hinge, then remove the right hinge.

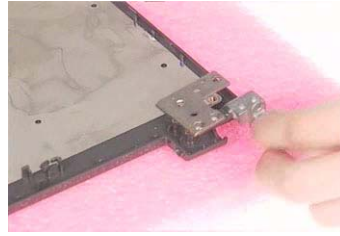

9. Remove the screw holding the left hinge, then remove the left hinge.



Disassembling the Main Unit

Removing the Keyboard

1. See “Removing the Battery” on page 50.
2. See “Removing the Middle Cover” on page 54.
3. Detach the keyboard from the main unit. Then turn over the keyboard.
4. Disconnect the keyboard cable and remove the keyboard.

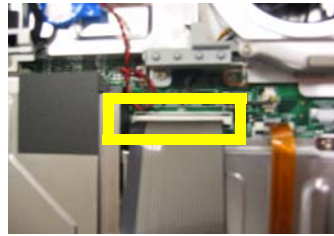

Removing the RTC Battery

1. See “Removing the Battery” on page 50.
2. See “Removing the Middle Cover” on page 54.
3. See “Removing the Keyboard” on page 61.
4. Disconnect the RTC battery cable then remove it.



Removing the Middle Cover Hook /Fan

1. See “Removing the Battery” on page 50.
2. See “Removing the Middle Cover” on page 54.
3. See “Removing the Keyboard” on page 61.
4. Remove the two screws holding the middle cover hook, then remove it.

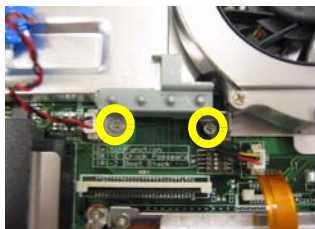

Removing the Thermal Module

1. See “Removing the Battery” on page 50.
2. See “Removing the Middle Cover” on page 54.
3. See “Removing the Keyboard” on page 61.
4. See “Removing the Middle Cover Hook /Fan” on page 61.
5. Disconnect the fan cable then remove the four screws fastening the thermal module.

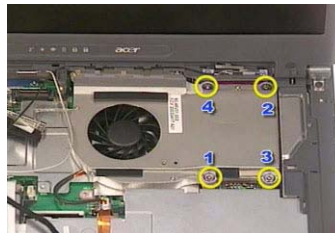
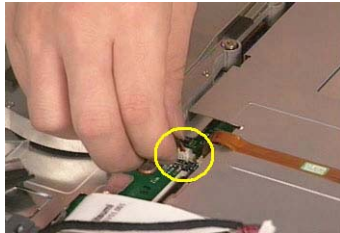

6. Then remove the thermal module.

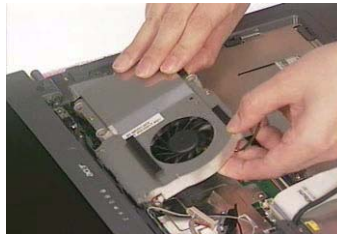

Removing the Processor

1. See “Removing the Battery” on page 50.
2. See “Removing the Middle Cover” on page 54.
3. See “Removing the Keyboard” on page 61.
4. See “Removing the RTC Battery” on page 61.
5. See “Removing the Middle Cover Hook /Fan” on page 61.
6. See “Removing the Thermal Module” on page 62.
7. Lift up the CPU socket lever. Then remove the CPU. Remember to press down the lever as the video shows after you remove the CPU.

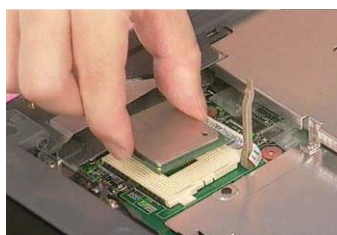
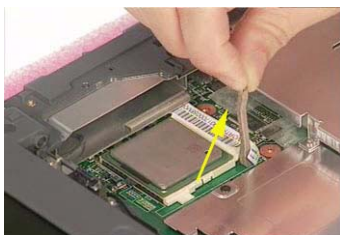

Installing the Processor

1. See “Removing the Battery” on page 50.

2. See “Removing the Middle Cover” on page 54.
3. See “Removing the Keyboard” on page 61.
4. See “Removing the RTC Battery” on page 61.
5. See “Removing the Middle Cover Hook /Fan” on page 61.
6. See “Removing the Thermal Module” on page 62.
7. Lift up the CPU lever, then place the CPU back to the CPU socket. Please remember to press the CPU lever after you put the CPU back to the socket.

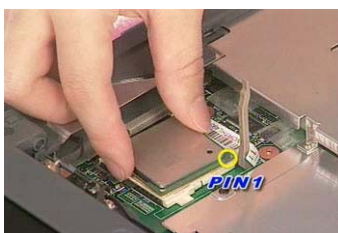
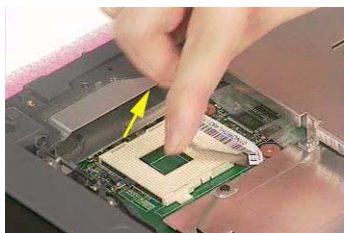

Removing the Upper Case Assembly

1. See “Removing the Keyboard” on page 61.
2. Disconnect the touchpad cable.

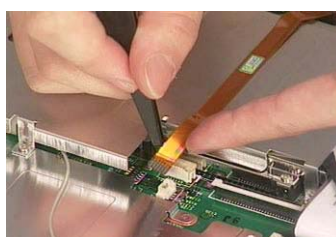
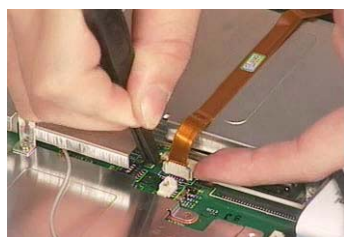

3. Remove the 5 screws that secure the upper case to the lower case. Then turn over the main unit and remove the 15 screws holding the lower case to the upper case.

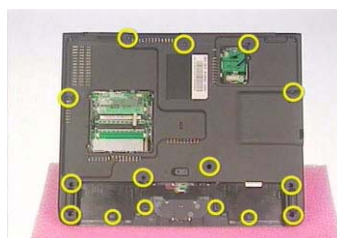

4. Then take the upper case assembly off the main unit.



Removing the Touchpad Board

1. See “Removing the Battery” on page 50.
2. See “Removing the Middle Cover” on page 54.
3. See “Removing the Keyboard” on page 61.
4. See “Removing the Upper Case Assembly” on page 63.
5. To detach the touch pad board, first disconnect the touch pad cable from the touch pad board with a plastic tweezers. Then release the touchpad cover lock on the back as the picture shows.

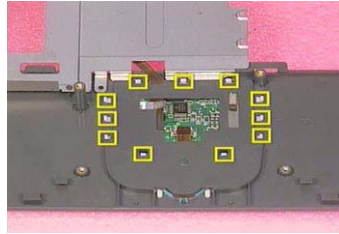

6. Remove the touchpad cover, then remove the touchpad button pad. Finally remove the touchpad board from the upper case.



Removing the Touchpad Cable

1. See “Removing the Battery” on page 50.
2. See “Removing the Middle Cover” on page 54.
3. See “Removing the LCD Module” on page 55.
4. See “Removing the Keyboard” on page 61.
5. See “Removing the Upper Case Assembly” on page 63.
6. See “Removing the Touchpad Board” on page 64.
7. Remove the touchpad scroll key then remove the touchpad cable.

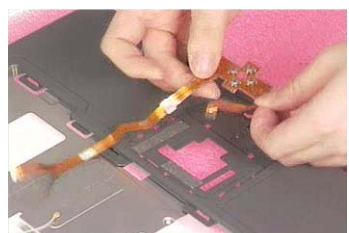
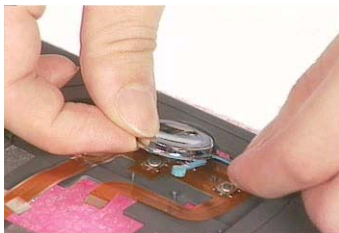

Removing the VGA Thermal Plate

1. See “Removing the Battery” on page 50.

2. See “Removing the Middle Cover” on page 54.
3. See “Removing the Keyboard” on page 61.
4. See “Removing the Middle Cover Hook /Fan” on page 61.
5. See “Removing the Thermal Module” on page 62.
6. Remove the seven screws holding the VGA thermal plate then remove it.



Removing the CPU Heatsink Plate

1. See “Removing the Battery” on page 50.
2. See “Removing the Middle Cover” on page 54.
3. See “Removing the Keyboard” on page 61.
4. See “Removing the Middle Cover Hook /Fan” on page 61.
5. See “Removing the Thermal Module” on page 62.
6. Remove two screws that fasten the CPU heatsink plate then remove it.

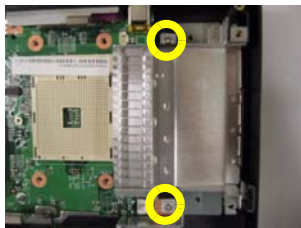

Removing the Second Fan Bracket

1. See “Removing the Battery” on page 50.
2. See “Removing the Middle Cover” on page 54.
3. See “Removing the LCD Module” on page 55.
4. See “Removing the RTC Battery” on page 61.
5. See “Removing the Middle Cover Hook /Fan” on page 61.
6. See “Removing the Thermal Module” on page 62.
7. Remove the four screws that fasten the second fan bracket then remove the bracket.

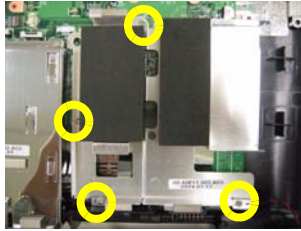

Removing the ODD Module(1)

1. See “Removing the Battery” on page 50.
2. Remove the screw that fastens the ODD bracket on the bottom. Push the ODD module at the point the red arrow indicates hard. Then remove the ODD module from the lower case.



NOTE: If you need to replace the ODD module only, you can remove the ODD module as the steps above.

Removing the ODD Module(2)

1. See “Removing the Battery” on page 50.
2. See “Removing the Middle Cover” on page 54.
3. See “Removing the Keyboard” on page 61.
4. See “Removing the Upper Case Assembly” on page 63.
5. See “Removing the Thermal Module” on page 62.
6. See “Removing the VGA Thermal Plate” on page 64.
7. Push the ODD module outwards then take the ODD out of the support bracket. Remove the screw that fastens the ODD support bracket then remove it.

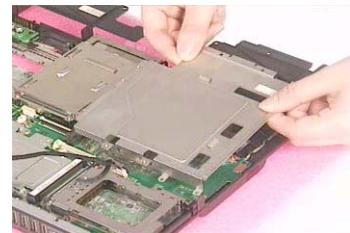
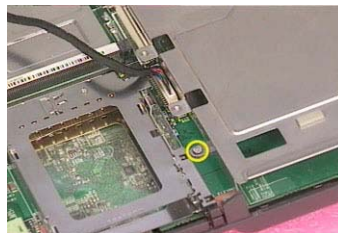

Removing the HDD Bracket

1. See “Removing the Battery” on page 50.
2. See “Removing the Middle Cover” on page 54.
3. See “Removing the Keyboard” on page 61.

4. See “Removing the Upper Case Assembly” on page 63.
5. Remove the four screws holding the HDD bracket, then remove the HDD bracket.

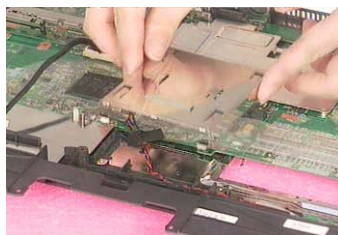
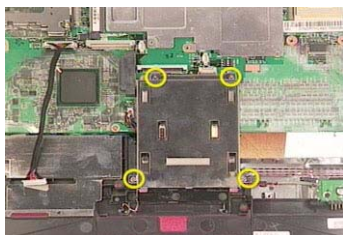

Removing the Main Board

1. See “Removing the Battery” on page 50.
2. See “Removing the Middle Cover” on page 54.
3. See “Removing the Keyboard” on page 61.
4. See “Removing the Upper Case Assembly” on page 63.
5. See “Removing the Middle Cover Hook /Fan” on page 61.
6. See “Removing the Thermal Module” on page 62.
7. See “Removing the VGA Thermal Plate” on page 64.
8. See “Removing the CPU Heatsink Plate” on page 65.
9. See “Removing the Second Fan Bracket” on page 65.
10. See “Removing the ODD Module(2)” on page 66.
11. See “Removing the HDD Bracket” on page 66.
12. Disconnect the launch board cable. Tear off the tape that fastens the speaker set cable. Then disconnect the speaker set cable.

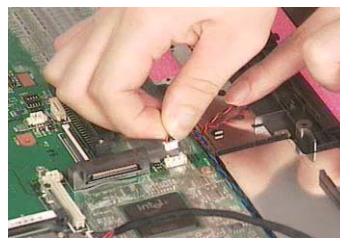
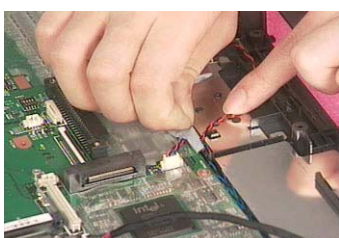
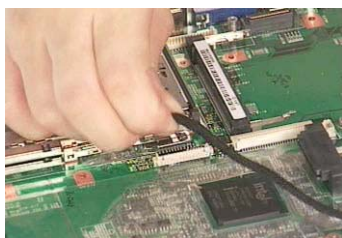

13. Remove the two screws holding the main board as the picture shows. Remove another two screws that fasten the main board. Then detach the main board from the lower case carefully.

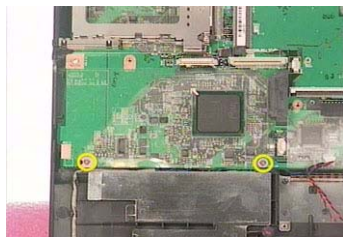

Removing the DC Board

1. See “Removing the Battery” on page 50.
2. See “Removing the Middle Cover” on page 54.
3. See “Removing the Keyboard” on page 61.
4. See “Removing the Upper Case Assembly” on page 63.
5. See “Removing the Middle Cover Hook /Fan” on page 61.
6. See “Removing the Thermal Module” on page 62.
7. See “Removing the VGA Thermal Plate” on page 64.
8. See “Removing the CPU Heatsink Plate” on page 65.
9. See “Removing the Second Fan Bracket” on page 65.
10. See “Removing the ODD Module(2)” on page 66.
11. See “Removing the HDD Bracket” on page 66.
12. See “Removing the Main Board” on page 67.
13. Remove the two screws that fasten the DC board. Then detach the DC board from the lower case.

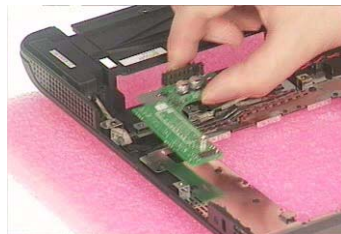
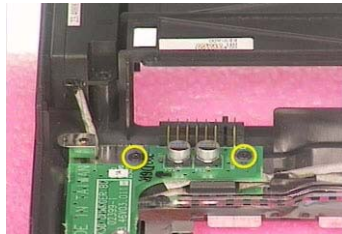

Removing the I/O Port Bracket

1. See “Removing the Battery” on page 50.
2. See “Removing the Middle Cover” on page 54.
3. See “Removing the Keyboard” on page 61.
4. See “Removing the Upper Case Assembly” on page 63.
5. See “Removing the Middle Cover Hook /Fan” on page 61.
6. See “Removing the Thermal Module” on page 62.
7. See “Removing the VGA Thermal Plate” on page 64.
8. See “Removing the CPU Heatsink Plate” on page 65.
9. See “Removing the Second Fan Bracket” on page 65.
10. See “Removing the ODD Module(2)” on page 66.
11. See “Removing the HDD Bracket” on page 66.
12. See “Removing the Main Board” on page 67.
13. Remove the four hex screws to detach the I/O port bracket from the main board.



Removing the PCMCIA Slot

1. See “Removing the Battery” on page 50.
2. See “Removing the Middle Cover” on page 54.
3. See “Removing the Keyboard” on page 61.
4. See “Removing the Upper Case Assembly” on page 63.
5. See “Removing the Middle Cover Hook /Fan” on page 61.
6. See “Removing the Thermal Module” on page 62.
7. See “Removing the VGA Thermal Plate” on page 64.
8. See “Removing the CPU Heatsink Plate” on page 65.
9. See “Removing the Second Fan Bracket” on page 65.
10. See “Removing the ODD Module(2)” on page 66.
11. See “Removing the HDD Bracket” on page 66.
12. See “Removing the Main Board” on page 67.
13. Remove the four screws that secure the PCMCIA slot, then remove the PCMCIA slot from the lower case.

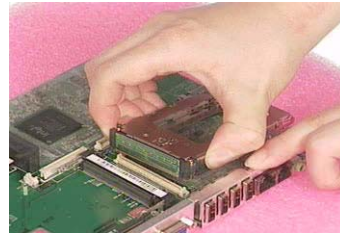
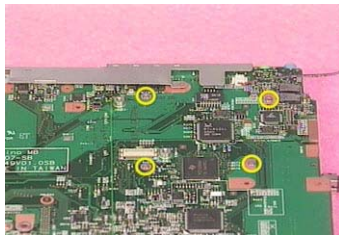

Removing the Speaker Set

1. See “Removing the Battery” on page 50.
2. See “Removing the Middle Cover” on page 54.
3. See “Removing the Keyboard” on page 61.
4. See “Removing the Upper Case Assembly” on page 63.
5. See “Removing the Middle Cover Hook /Fan” on page 61.
6. See “Removing the Thermal Module” on page 62.
7. See “Removing the VGA Thermal Plate” on page 64.
8. See “Removing the CPU Heatsink Plate” on page 65.
9. See “Removing the Second Fan Bracket” on page 65.

-
10. See “Removing the ODD Module(2)” on page 66.
 11. See “Removing the HDD Bracket” on page 66.
 12. See “Removing the Main Board” on page 67.
 13. See “Removing the DC Board” on page 68.
 14. Tear off the tape fastening the speaker set cable. Then remove the four screws that secure the speaker set. Remove the speaker set from the lower case.

System Upgrade Procedure

Base Unit to Wireless Unit

1. Turn out the two screws fastening the modem cover then open the cover.
2. Connect the wireless antennae.
3. Insert the wireless LAN board to the wireless socket on the main board.
4. Close the modem cover and fasten the cover with the two screws.

NOTE: You must connect the wireless antennae before you insert the wireless LAN board to the socket. If you insert the wireless LAN card first, the pressure you press to fasten the wireless antennae may damage the main board.



Troubleshooting

Use the following procedure as a guide for computer problems.

NOTE: The diagnostic tests are intended to test only Acer products. Non-Acer products, prototype cards, or modified options can give false errors and invalid system responses.

1. Obtain the failing symptoms in as much detail as possible.
2. Verify the symptoms by attempting to re-create the failure by running the diagnostic test or by repeating the same operation.
3. Use the following table with the verified symptom to determine which page to go to.

Symptoms (Verified)	Go To
Power failure. (The power indicator does not go on or stay on.)	"Power System Check" on page 74.
POST does not complete. No beep or error codes are indicated.	"Power-On Self-Test (POST) Error Message" on page 77 "Undetermined Problems" on page 89
POST detects an error and displayed messages on screen.	"Error Message List" on page 78
Other symptoms (i.e. LCD display problems or others).	"Power-On Self-Test (POST) Error Message" on page 77
Symptoms cannot be re-created (intermittent problems).	Use the customer-reported symptoms and go to "Power-On Self-Test (POST) Error Message" on page 77 "Intermittent Problems" on page 88 "Undetermined Problems" on page 89

System Check Procedures

External Diskette Drive Check

Do the following to isolate the problem to a controller, driver, or diskette. A write-enabled, diagnostic diskette is required.

NOTE: Make sure that the diskette does not have more than one label attached to it. Multiple labels can cause damage to the drive or cause the drive to fail.

Do the following to select the test device.

1. Boot from the diagnostics diskette and start the diagnostics program.
2. See if FDD Test is passed as the program runs to FDD Test.
3. Follow the instructions in the message window.

If an error occurs with the internal diskette drive, reconnect the diskette connector on the system board.

If the error still remains:

1. Reconnect the external diskette drive/DVD-ROM module.
2. Replace the external diskette drive/CD-ROM module.
3. Replace the main board.

External CD-ROM Drive Check

Do the following to isolate the problem to a controller, drive, or CD-ROM. Make sure that the CD-ROM does not have any label attached to it. The label can cause damage to the drive or can cause the drive to fail.

Do the following to select the test device:

1. Boot from the diagnostics diskette and start the diagnostics program.
2. See if CD-ROM Test is passed when the program runs to CD-ROM Test.
3. Follow the instructions in the message window.

If an error occurs, reconnect the connector on the System board. If the error still remains:

1. Reconnect the external diskette drive/CD-ROM module.
2. Replace the external diskette drive/CD-ROM module.
3. Replace the main board.

Keyboard or Auxiliary Input Device Check

Remove the external keyboard if the internal keyboard is to be tested.

If the internal keyboard does not work or an unexpected character appears, make sure that the flexible cable extending from the keyboard is correctly seated in the connector on the system board.

If the keyboard cable connection is correct, run the Keyboard Test.

If the tests detect a keyboard problem, do the following one at a time to correct the problem. Do not replace a non-defective FRU:

1. Reconnect the keyboard cables.
2. Replace the keyboard.
3. Replace the main board.

The following auxiliary input devices are supported by this computer:

- Numeric keypad
- External keyboard

If any of these devices do not work, reconnect the cable connector and repeat the failing operation.

Memory check

Memory errors might stop system operations, show error messages on the screen, or hang the system.

1. Boot from the diagnostics diskette and start the doagmpstotics program (please refer to main board).
2. Go to the diagnostic memory in the test items.
3. Press F2 in the test items.
4. Follow the instructions in the message window.

NOTE: Make sure that the DIMM is fully installed into the connector. A loose connection can cause an error.

Power System Check

To verify the symptom of the problem, power on the computer using each of the following power sources:

1. Remove the battery pack.
2. Connect the power adapter and check that power is supplied.
3. Disconnect the power adapter and install the charged battery pack; then check that power is supplied by the battery pack.

If you suspect a power problem, see the appropriate power supply check in the following list:

- “Check the Power Adapter” on page 75
- “Check the Battery Pack” on page 76

Check the Power Adapter

Unplug the power adapter cable from the computer and measure the output voltage at the plug of the power adapter cable. See the following figure

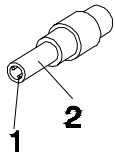

Pin 1: +19 to +20.5V
Pin 2: 0V, Ground

1. If the voltage is not correct, replace the power adapter.
2. If the voltage is within the range, do the following:
 - Replace the System board.
 - If the problem is not corrected, see “Undetermined Problems” on page 89.
 - If the voltage is not correct, go to the next step.

NOTE: An audible noise from the power adapter does not always indicate a defect.

3. If the power-on indicator does not light up, check the power cord of the power adapter for correct continuity and installation.
4. If the operational charge does not work, see “Check the Battery Pack” on page 76.

Check the Battery Pack

To check the battery pack, do the following:

From Software:

1. Check out the Power Management in control Panel
2. In Power Meter, confirm that if the parameters shown in the screen for Current Power Source and Total Battery Power Remaining are correct.
3. Repeat the steps 1 and 2, for both battery and adapter.
4. This helps you identify first the problem is on recharging or discharging.

From Hardware:

1. Power off the computer.
2. Remove the battery pack and measure the voltage between battery terminals 1(+) and 6(ground). See the following figure

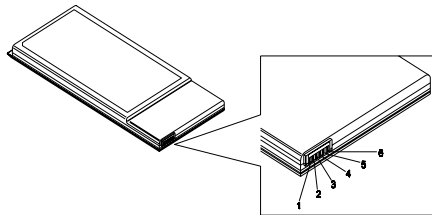

3. If the voltage is still less than 7.5 Vdc after recharging, replace the battery.

To check the battery charge operation, use a discharged battery pack or a battery pack that has less than 50% of the total power remaining when installed in the computer.

If the battery status indicator does not light up, remove the battery pack and let it return to room temperature. Re-install the battery pack.

If the charge indicator still does not light up, replace the battery pack. If the charge indicator still does not light up, replace the DC/DC charger board.

Touchpad Check

If the touchpad doesn't work, do the following actions one at a time to correct the problem. Do not replace a non-defective FRU:

1. Reconnect the touchpad cables.
2. Replace the touchpad.
3. Replace the system board.

After you use the touchpad, the pointer drifts on the screen for a short time. This self-acting pointer movement can occur when a slight, steady pressure is applied to the touchpad pointer. This symptom is not a hardware problem. No service actions are necessary if the pointer movement stops in a short period of time.

Power-On Self-Test (POST) Error Message

The POST error message index lists the error message and their possible causes. The most likely cause is listed first.

NOTE: Perform the FRU replacement or actions in the sequence shown in FRU/Action column, if the FRU replacement does not solve the problem, put the original part back in the computer. Do not replace a non-defective FRU.

This index can also help you determine the next possible FRU to be replaced when servicing a computer.

If the symptom is not listed, see “Undetermined Problems” on page 89.

The following lists the error messages that the BIOS displays on the screen and the error symptoms classified by function.

NOTE: Most of the error messages occur during POST. Some of them display information about a hardware device, e.g., the amount of memory installed. Others may indicate a problem with a device, such as the way it has been configured.

NOTE: If the system fails after you make changes in the BIOS Setup Utility menus, reset the computer, enter Setup and install Setup defaults or correct the error.

Index of Error Messages

Error Code List

Error Codes	Error Messages
006	Equipment Configuration Error Causes: 1. CPU BIOS Update Code Mismatch 2. IDE Primary Channel Master Drive Error (The causes will be shown before "Equipment Configuration Error")
010	Memory Error at xxxx:xxxx:xxxxh (R:xxxxh, W:xxxxh)
070	Real Time Clock Error
071	CMOS Battery Bad
072	CMOS Checksum Error
110	System disabled. Incorrect password is specified.
<No error code>	Battery critical LOW In this situation BIOS will issue 4 short beeps then shut down system, no message will show.
<No error code>	Thermal critical High In this situation BIOS will shut down system, not show message.

Error Message List

Error Messages	FRU/Action in Sequence
Failure Fixed Disk	Reconnect hard disk drive connector. "Load Default Settings" in BIOS Setup Utility. Hard disk drive System board
Stuck Key	see "Keyboard or Auxiliary Input Device Check" on page 73.
Keyboard error	see "Keyboard or Auxiliary Input Device Check" on page 73.
Keyboard Controller Failed	see "Keyboard or Auxiliary Input Device Check" on page 73.
Keyboard locked - Unlock key switch	Unlock external keyboard
Monitor type does not match CMOS - Run Setup	Run "Load Default Settings" in BIOS Setup Utility.
Shadow RAM Failed at offset: nnnn	BIOS ROM System board
System RAM Failed at offset: nnnn	DIMM System board
Extended RAM Failed at offset: nnnn	DIMM System board
System battery is dead - Replace and run Setup	Replace RTC battery and Run BIOS Setup Utility to reconfigure system time, then reboot system.
System CMOS checksum bad - Default configuration used	RTC battery Run BIOS Setup Utility to reconfigure system time, then reboot system.
System timer error	RTC battery Run BIOS Setup Utility to reconfigure system time, then reboot system. System board

Error Message List

Error Messages	FRU/Action in Sequence
Real time clock error	RTC battery Run BIOS Setup Utility to reconfigure system time, then reboot system. System board
Previous boot incomplete - Default configuration used	Run "Load Default Settings" in BIOS Setup Utility. RTC battery System board
Memory size found by POST differed from CMOS	Run "Load Default Settings" in BIOS Setup Utility. DIMM System board
Diskette drive A error	Check the drive is defined with the proper diskette type in BIOS Setup Utility See "External Diskette Drive Check" on page 73.
Incorrect Drive A type - run SETUP	Check the drive is defined with the proper diskette type in BIOS Setup Utility
System cache error - Cache disabled	System board
CPU ID:	System board
DMA Test Failed	DIMM System board
Software NMI Failed	DIMM System board
Fail-Safe Timer NMI Failed	DIMM System board
Device Address Conflict	Run "Load Default Settings" in BIOS Setup Utility. RTC battery System board
Allocation Error for device	Run "Load Default Settings" in BIOS Setup Utility. RTC battery System board
Failing Bits: nnnn	DIMM BIOS ROM System board
Fixed Disk n	None
Invalid System Configuration Data	BIOS ROM System board
I/O device IRQ conflict	Run "Load Default Settings" in BIOS Setup Utility. RTC battery System board
Operating system not found	Enter Setup and see if fixed disk and drive A: are properly identified. Diskette drive Hard disk drive System board

Error Message List

No beep Error Messages	FRU/Action in Sequence
No beep, power-on indicator turns off and LCD is blank.	Power source (battery pack and power adapter). See "Power System Check" on page 74. Ensure every connector is connected tightly and correctly. Reconnect the DIMM. LED board. System board.
No beep, power-on indicator turns on and LCD is blank.	Power source (battery pack and power adapter). See "Power System Check" on page 74. Reconnect the LCD connector Hard disk drive LCD inverter ID LCD cable LCD Inverter LCD System board
No beep, power-on indicator turns on and LCD is blank. But you can see POST on an external CRT.	Reconnect the LCD connectors. LCD inverter ID LCD cable LCD inverter LCD System board
No beep, power-on indicator turns on and a blinking cursor shown on LCD during POST.	Ensure every connector is connected tightly and correctly. System board
No beep during POST but system runs correctly.	Speaker System board

POST Code

Code	Beeps	POST Routine Description
02h		Verify Real Mode
03h		Disable Non-Maskable Interrupt (NMI)
04h		Get CPU type
06h		Initialize system hardware
08h		Initialize chipset with initial POST values
09h		Set IN POST flag
0Ah		Initialize CPU registers
0Bh		Enable CPU cache
0Ch		Initialize caches to initial POST values
0Eh		Initialize I/O component
0Fh		Initialize the local bus IDE
10h		Initialize Power Management
11h		Load alternate registers with initial POST values
12h		Restore CPU control word during warm boot
13h		Initialize PCI Bus Mastering devices
14h		Initialize keyboard controller
16h	1-2-2-3	BIOS ROM checksum
17h		Initialize cache before memory autosize
18h		8254 timer initialization
1Ah		8237 DMA controller initialization
1Ch		Reset Programmable Interrupt Controller
20h	1-3-1-1	Test DRAM refresh
22h	1-3-1-3	Test 8742 Keyboard Controller
24h		Set ES segment register to 4 GB
26h		Enable A20 line
28h		Autosize DRAM
29h		Initialize POST Memory Manager
2Ah		Clear 215 KB base RAM
2Ch	1-3-4-1	RAM failure on address line xxxx
2Eh	1-3-4-3	RAM failure on data bits xxxx of low byte of memory bus
2Fh		Enable cache before system BIOS shadow
30h	1-4-1-1	RAM failure on data bits xxxx of high byte of memory bus
32h		Test CPU bus-clock frequency
33h		Initialize Phoenix Dispatch Manager
36h		Warm start shut down
38h		Shadow system BIOS ROM
3Ah		Autosize cache
3Ch		Advanced configuration of chipset registers
3Dh		Load alternate registers with CMOS values
42h		Initialize interrupt vectors
45h		POST device initialization

Code	Beeps	POST Routine Description
46h	2-1-2-3	Check ROM copyright notice
48h		Check video configuration against CMOS
49h		Initialize PCI bus and devices
4Ah		Initialize all video adapters in system
4Bh		QuietBoot start (optional)
4Ch		Shadow video BIOS ROM
4Eh		Display BIOS copyright notice
50h		Display CPU type and speed
51h		Initialize EISA board
52h		Test keyboard
54h		Set key click if enabled
58h	2-2-3-1	Test for unexpected interrupts
59h		Initialize POST display service
5Ah		Display prompt "Press F2 to enter SETUP"
5Bh		Disable CPU cache
5Ch		Test RAM between 512 and 640 KB
60h		Test extended memory
62h		Test extended memory address lines
64h		Jump to User Patch1
66h		Configure advanced cache registers
67h		Initialize Multi Processor APIC
68h		Enable external and CPU caches
69h		Setup System Management Mode (SMM) area
6Ah		Display external L2 cache size
6Bh		Load custom defaults (optional)
6Ch		Display shadow-area message
6Eh		Display possible high address for UMB recovery
70h		Display error messages
72h		Check for configuration errors
76h		Check for keyboard errors
7Ch		Set up hardware interrupt vectors
7Eh		Initialize coprocessor if present
80h		Disable onboard Super I/O ports and IRQs
81h		Late POST device initialization
82h		Detect and install external RS232 ports
83h		Configure non-MCD IDE controllers
84h		Detect and install external parallel ports
85h		Initialize PC-compatible PnP ISA devices
86h		Re-initialize onboard I/O ports
87h		Configure Motherboard Configurable Devices (optional)
88h		Initialize BIOS Area
89h		Enable Non-Maskable Interrupts (NMI)
8Ah		Initialize Extended BIOS Data Area
8Bh		Test and initialize PS/2 mouse

Code	Beeps	POST Routine Description
8Ch		Initialize floppy controller
8Fh		Determine number of ATA drives (optional)
90h		Initialize hard-disk controllers
91h		Initialize local-bus hard-disk controllers
92h		Jump to UserPatch2
93h		Build MPTABLE for multi-processor boards
95h		Install CD ROM for boot
96h		Clear huge ES segment register
97h		Fixup Multi Processor table
98h	1-2	Search for option ROMs. One long, two short beeps on checksum failure.
99h		Check for SMART drive (optional)
9Ah		Shadow option ROMs
9Ch		Set up Power Management
9Dh		Initialize security engine (optional)
9Eh		Enable hardware interrupts
9Fh		Determine number of ATA and SCSI drives
A0h		Set time of day
A2h		Check key lock
A4h		Initialize Typematic rate
A8h		Erase F2 prompt
AAh		Scan for F2 key stroke
ACh		Enter SETUP
AEh		Clear Boot flag
B0h		Check for errors
B2h		POST done- prepare to boot operating system
B4h	1	One short beep before boot
B5h		Terminate QuietBoot (optional)
B6h		Check password (optional)
B9h		Prepare Boot
BAh		Initialize DMI parameters
BBh		Initialize PnP Option ROMs
BCh		Clear parity checkers
BDh		Display MultiBoot menu
BEh		Clear screen (optional)
BFh		Check virus and backup reminders
C0h		Try to boot with INT 19
C1h		Initialize POST Error Manager (PEM)
C2h		Initialize error logging
C3h		Initialize error display function
C4h		Initialize system error handler
C5h		PnPnd dual CMOS (optional)
C6h		Initialize notebook docking (optional)
C7h		Initialize notebook docking late
C8h		Force check (optional)
C9h		Extended checksum (optional)

Code	Beeps	POST Routine Description
D2h		Unknown interrupt

Code	Beeps	For Boot Block in Flash ROM
E0h		Initialize the chipset
E1h		Initialize the bridge
E2h		Initialize the CPU
E3h		Initialize the system timer
E4h		Initialize system I/O
E5h		Check force recovery boot
E6h		Checksum BIOS ROM
E7h		Go to BIOS
E8h		Set Huge Segment
E9h		Initialize Multi Processor
EAh		Initialize OEM special code
EBh		Initialize PIC and DMA
ECh		Initialize Memory type
EDh		Initialize Memory size
EEh		Shadow Boot Block
EFh		System memory test
F0h		Initialize interrupt vectors
F1h		Initialize Run Time Clock
F2h		Initialize video
F3h		Initialize System Management Mode
F4h	1	Output one beep before boot
F5h		Boot to Mini DOS
F6h		Clear Huge Segment
F7h		Boot to Full DOS

Index of Symptom-to-FRU Error Message

LCD-Related Symptoms

Symptom / Error	Action in Sequence
LCD backlight doesn't work LCD is too dark LCD brightness cannot be adjusted LCD contrast cannot be adjusted	Enter BIOS Utility to execute "Load Setup Default Settings", then reboot system. Reconnect the LCD connectors. Keyboard (if contrast and brightness function key doesn't work). LCD inverter ID LCD cable LCD inverter LCD System board
Unreadable LCD screen Missing pels in characters Abnormal screen Wrong color displayed	Reconnect the LCD connector LCD inverter ID LCD cable LCD inverter LCD System board
LCD has extra horizontal or vertical lines displayed.	LCD inverter ID LCD inverter LCD cable LCD System board

Indicator-Related Symptoms

Symptom / Error	Action in Sequence
Indicator incorrectly remains off or on, but system runs correctly	Reconnect the inverter board Inverter board System board

Power-Related Symptoms

Symptom / Error	Action in Sequence
Power shuts down during operation	Power source (battery pack and power adapter). See "Power System Check" on page 74. Battery pack Power adapter Hard drive & battery connection board System board
The system doesn't power-on.	Power source (battery pack and power adapter). See "Power System Check" on page 74. Battery pack Power adapter Hard drive & battery connection board System board
The system doesn't power-off.	Power source (battery pack and power adapter). See "Power System Check" on page 74. Hold and press the power switch for more than 4 seconds. System board

Power-Related Symptoms

Symptom / Error	Action in Sequence
Battery can't be charged	See "Check the Battery Pack" on page 76. Battery pack System board

PCMCIA-Related Symptoms

Symptom / Error	Action in Sequence
System cannot detect the PC Card (PCMCIA)	PCMCIA slot assembly System board
PCMCIA slot pin is damaged.	PCMCIA slot assembly

Memory-Related Symptoms

Symptom / Error	Action in Sequence
Memory count (size) appears different from actual size.	Enter BIOS Setup Utility to execute "Load Default Settings, then reboot system. DIMM System board

Speaker-Related Symptoms

Symptom / Error	Action in Sequence
In Windows, multimedia programs, no sound comes from the computer.	Audio driver Speaker System board
Internal speakers make noise or emit no sound.	Speaker System board

Power Management-Related Symptoms

Symptom / Error	Action in Sequence
The system will not enter hibernation	Keyboard (if control is from the keyboard) Hard disk drive System board
The system doesn't enter hibernation mode and four short beeps every minute.	See "Hibernation Mode" on page 29. Press Fn+  and see if the computer enters hibernation mode. Touchpad Keyboard Hard disk connection board Hard disk drive System board
The system doesn't enter standby mode after closing the LCD	See "Hibernation Mode" on page 29. LCD cover switch System board
The system doesn't resume from hibernation mode.	See "Hibernation Mode" on page 29. Hard disk connection board Hard disk drive System board
The system doesn't resume from standby mode after opening the LCD.	See "Hibernation Mode" on page 29. LCD cover switch System board

Power Management-Related Symptoms

Symptom / Error	Action in Sequence
Battery fuel gauge in Windows doesn't go higher than 90%.	Remove battery pack and let it cool for 2 hours. Refresh battery (continue use battery until power off, then charge battery). Battery pack System board
System hangs intermittently.	Reconnect hard disk/CD-ROM drives. Hard disk connection board System board

Peripheral-Related Symptoms

Symptom / Error	Action in Sequence
System configuration does not match the installed devices.	Enter BIOS Setup Utility to execute "Load Default Settings", then reboot system. Reconnect hard disk/CD-ROM/diskette drives.
External display does not work correctly.	Press Fn+F5, LCD/CRT/Both display switching System board
USB does not work correctly	System board
Print problems.	Ensure the "Parallel Port" in the "Onboard Devices Configuration" of BIOS Setup Utility is set to Enabled. Onboard Devices Configuration Run printer self-test. Printer driver Printer cable Printer System Board
Serial or parallel port device problems.	Ensure the "Serial Port" in the Devices Configuration" of BIOS Setup Utility is set to Enabled. Device driver Device cable Device System board

Keyboard/Touchpad-Related Symptoms

Symptom / Error	Action in Sequence
Keyboard (one or more keys) does not work.	Reconnect the keyboard cable. Keyboard System board
Touchpad does not work.	Reconnect touchpad cable. Touchpad board System board

Modem-Related Symptoms

Symptom / Error	Action in Sequence
Internal modem does not work correctly.	Modem phone port modem combo board System board

NOTE: If you cannot find a symptom or an error in this list and the problem remains, see "Undetermined Problems" on page 89.

Intermittent Problems

Intermittent system hang problems can be caused by a variety of reasons that have nothing to do with a hardware defect, such as: cosmic radiation, electrostatic discharge, or software errors. FRU replacement should be considered only when a recurring problem exists.

When analyzing an intermittent problem, do the following:

1. Run the advanced diagnostic test for the system board in loop mode at least 10 times.
2. If no error is detected, do not replace any FRU.
3. If any error is detected, replace the FRU. Rerun the test to verify that there are no more errors.

Undetermined Problems

The diagnostic problems does not identify which adapter or device failed, which installed devices are incorrect, whether a short circuit is suspected, or whether the system is inoperative.

Follow these procedures to isolate the failing FRU (do not isolate non-defective FRU).

NOTE: Verify that all attached devices are supported by the computer.

NOTE: Verify that the power supply being used at the time of the failure is operating correctly. (See "Power System Check" on page 74):

1. Power-off the computer.
2. Visually check them for damage. If any problems are found, replace the FRU.
3. Remove or disconnect all of the following devices:
 - Non-Acer devices
 - Printer, mouse, and other external devices
 - Battery pack
 - Hard disk drive
 - DIMM
 - CD-ROM/Diskette drive Module
 - PC Cards
4. Power-on the computer.
5. Determine if the problem has changed.
6. If the problem does not recur, reconnect the removed devices one at a time until you find the failing FRU.
7. If the problem remains, replace the following FRU one at a time. Do not replace a non-defective FRU:
 - System board
 - LCD assembly

How to Build NAPP Master Hard Disc Drive

CD to Disk Recovery

1. Prepare NAPP CD, Recovery CD and System CD.
2. Put NAPP CD into the optical drive. Then boot up the system.
3. The system will ask you if you want to build NAPP Master HDD. Please press any key to continue.

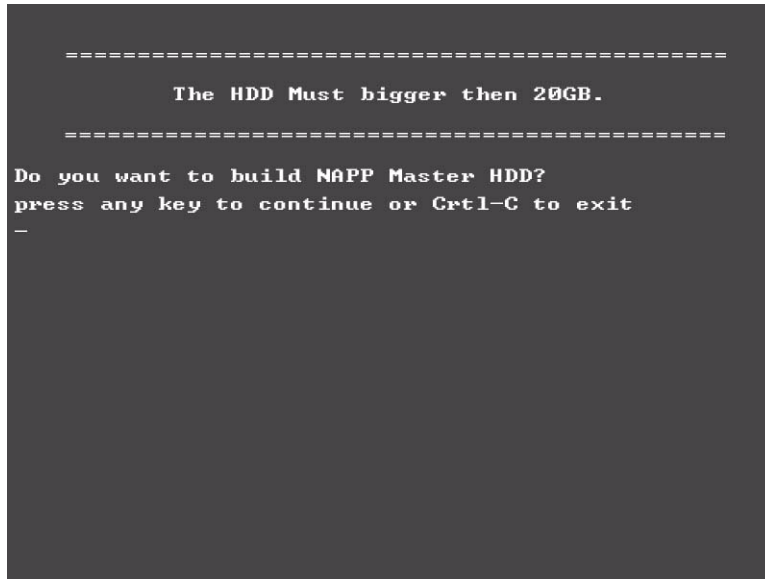

4. NAPP CD will start to preload the system, please click [Y].

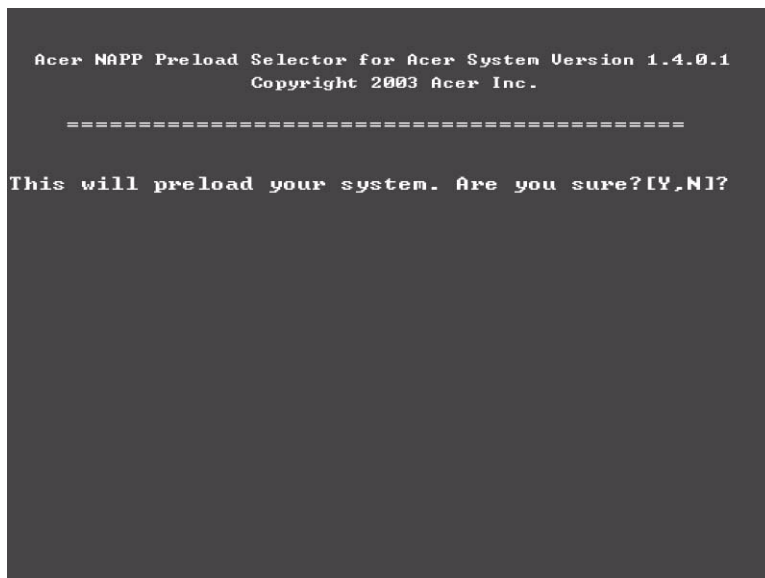

5. Select CD to Disk Recovery.

```
Method Selector
=====
1. Disk To Disk Recovery
2. CD to Disk Recovery
X. Quit

Please select your Choose...[1,2,x]?
```

6. Put the Recovery CD to the optical drive. This step is to create image files to the system, you do not have to put the Recovery CD to the optical drive in order. Place one Recovery CD to the drive at one time till you finish all Recovery CDs.

```
Please Insert Any Recovery CD

Please Press Any Key to Continue.
Press any key to continue...
_
```

After you place the Recovery CD to the optical drive, you will see the display below.

```
Please Wait for COPYING .....  
X:\images \70E40101.HDD
```

7. Then insert the System CD to the optical drive.

```
Please Insert the System CD  
  
Please Press Any Key to Continue.  
Press any key to continue...  
_
```

8. You will see the screen displaying "PASS" when the system has built NAPP Master hard disc drive.

```
Acer NAPP Preload Selector for Acer System Version 1.4.0.1
Copyright 2003 Acer Inc.
```

```
=====
This will preload your system. Are you sure?[Y,N]?
```

5. Select Disk to Disk Recovery. Then choose Single Language or Multi-Languages Recovery.
NOTE: For Multi-Languages Recovery, not more than five languages could be loaded to the system.

```
Method Selector
```

- ```
=====
1. Single Language Recovery
2. Multi-Languages Recovery
X. Quit
```

```
Please select your Choose...[1,2,x]?
```

6. Put the Recovery CD to the optical drive. This step is to create image files to the system, you do not have to put the Recovery CD to the optical drive in order. Place one Recovery CD to the drive at one time till you finish all Recovery CDs.

---



```
Please Insert Any Recovery CD

Please Press Any Key to Continue.
Press any key to continue...
_
```

After you place the Recovery CD to the optical drive, you will see the display below.



```
Please Wait for COPYING
X:\images \70E40101.HDD
```

7. Then insert the System CD to the optical drive.



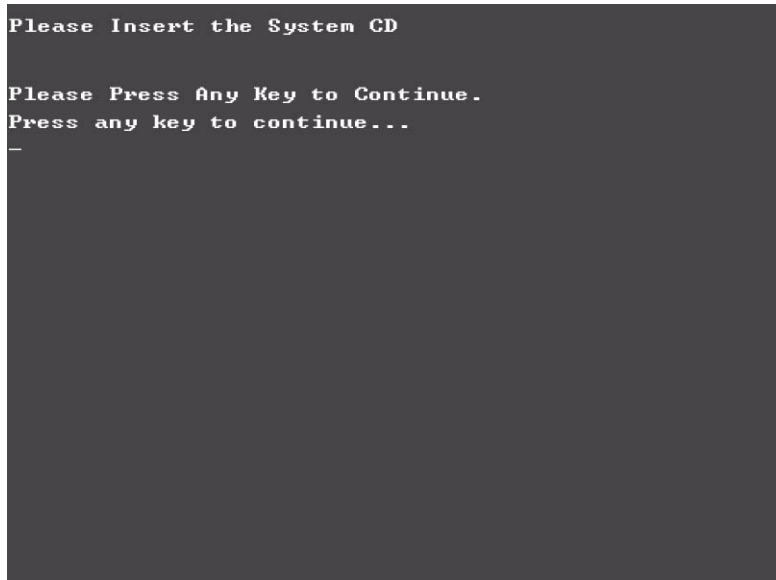

- 8. You will see the screen displaying "PASS" when the system has buit NAPP Master hard disc drive.







## Bottom View

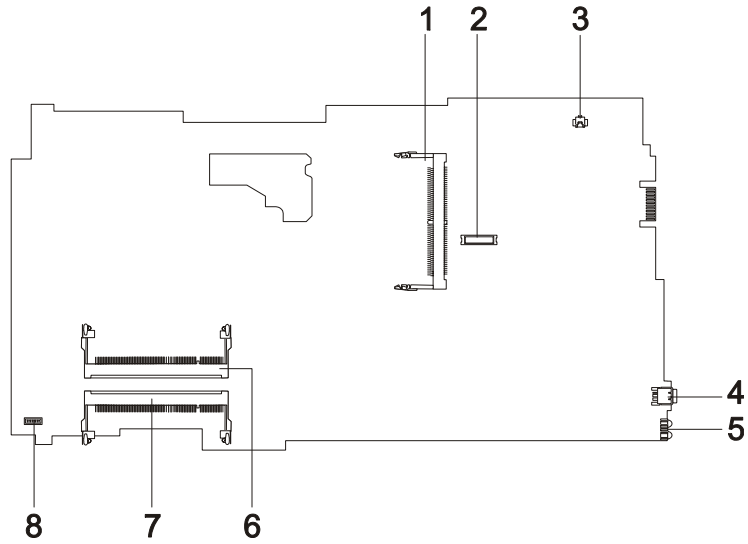

|   |      |                             |   |      |                            |
|---|------|-----------------------------|---|------|----------------------------|
| 1 | CN11 | Wireless LAN Card Connector | 5 | U93  | FIR Port                   |
| 2 | CN12 | Modem Board Connector       | 6 | DM1  | DIMM Socket 1              |
| 3 | CN10 | Modem Cable Connector       | 7 | DM2  | DIMM Socket 2              |
| 4 | SKT2 | IEEE 1394 Port              | 8 | BAT1 | DC Charger Board Connector |

### SW Settings

|                  | SW1-8 | SW2-7 | SW3-6 |
|------------------|-------|-------|-------|
| Chkpw Enable     | ON    | X     |       |
| Bootblock Enable | X     | ON    |       |

## FRU (Field Replaceable Unit) List

---

This chapter gives you the FRU (Field Replaceable Unit) listing in global configurations of Aspire 1360/1520. Refer to this chapter whenever ordering for parts to repair or for RMA (Return Merchandise Authorization).

Please note that WHEN ORDERING FRU PARTS, you should check the most up-to-date information available on your regional web or channel. For whatever reasons a part number change is made, it will not be noted on the printed Service Guide. For ACER AUTHORIZED SERVICE PROVIDERS, your Acer office may have a DIFFERENT part number code from those given in the FRU list of this printed Service Guide. You MUST use the local FRU list provided by your regional Acer office to order FRU parts for repair and service of customer machines.







**NOTE:** To scrap or to return the defective parts, you should follow the local government ordinance or regulations on how to dispose it properly, or follow the rules set by your regional Acer office on how to return it.



## Aspire 1360

| Picture                                                                             | No. | Partname And Description                                | Part Number  |
|-------------------------------------------------------------------------------------|-----|---------------------------------------------------------|--------------|
| <b>Adapter</b>                                                                      |     |                                                         |              |
|                                                                                     | N/S | ADAPTER 19V 90W 3PIN LITEON PA-1900-05QA                | TBD          |
|                                                                                     | N/S | ADAPTER 19V 90W 3PIN DELTA ADP-90SB                     | TBD          |
| <b>Battery</b>                                                                      |     |                                                         |              |
|    | N/S | RTC BATTERY LONGTRUM                                    | 23.T30V1.001 |
|    | 18  | BATTERY MODULE LI 8CELL 2000MAH SANYO                   | 6M.A36V1.001 |
|    | N/S | BATTERY LI 8CELL 2000MAH SANYO BTP-60A1                 | BT.T3003.001 |
|                                                                                     | N/S | BATTERY LI 8CELL SIMPLO BTP-58A1                        | BT.T3007.003 |
| <b>CASE/COVER/BRACKET ASSEMBLY</b>                                                  |     |                                                         |              |
|  |     | BATTERY COVER<br>(The cover should be silver not black) | 42.A30V1.001 |
| <b>Boards</b>                                                                       |     |                                                         |              |
|  |     | VGA BOARD NV36-64M(DIP)                                 | TBD          |
|  |     | DC-DC CHARGER BOARD                                     | 55.T30V1.001 |

## Aspire 1360

| Picture                                                                             | No. | Partname And Description                  | Part Number  |
|-------------------------------------------------------------------------------------|-----|-------------------------------------------|--------------|
|    |     | WIRELESS LAN BOARD 802.11BG<br>FOXCONN    | 54.A36V1.001 |
|    |     | MODEM BOARD AMBIT<br>T60M283.10(01)       | 54.09011.544 |
|                                                                                     |     | MODEM/BLEETOOTH BOARD AMBIT<br>T60M665.00 | 54.09061.001 |
|    |     | LAUNCH BOARD                              | 55.T30V1.002 |
| Cables                                                                              |     |                                           |              |
|                                                                                     |     | POWER CORD 10A 125V US                    | 27.01518.311 |
|    |     | COVER SWITCH CABLE                        | 50.A30V1.004 |
|  |     | LAUNCH BOARD CABLE                        | 50.T30V1.011 |
|  |     | MODEM CABLE 2PIN 2CONNECTOR<br>55MM       | 50.41T11.002 |
| Case/Cover/Bracket Assembly                                                         |     |                                           |              |
|  |     | MODEM COVER W/SCREWS                      | 42.A20V1.001 |
|  |     | HINGE CAP RIGHT                           | 42.A30V1.002 |



## Aspire 1360

| Picture                                                                             | No. | Partname And Description                                     | Part Number  |
|-------------------------------------------------------------------------------------|-----|--------------------------------------------------------------|--------------|
|    |     | HINGE CAP LEFT                                               | 42.A30V1.003 |
|    |     | HDD SUPPORT BRACKET                                          | 33.A30V1.002 |
|    |     | OPTICAL DEVICE SUPPORT BRACKET                               | 33.A30V1.001 |
|   |     | 2ND FAN BRACKET                                              | 33.A20V1.002 |
|  |     | TOUCHPAD COVER                                               | 42.A30V1.004 |
|  |     | MIDDLE COVER HOOK                                            | 31.A20V1.001 |
|  |     | UPPER CASE W/COVERSWITCH CABLE & TOUCHPAD CABLE & SCROLL KEY | 60.A36V1.002 |
|  |     | MIDDLE COVER W/LAUNCH BOARD                                  | 60.A36V1.003 |

## Aspire 1360

| Picture                                                                             | No. | Partname And Description                       | Part Number  |
|-------------------------------------------------------------------------------------|-----|------------------------------------------------|--------------|
|    |     | LOWER CASE W/DIMM COVER& SPEAKER W/O MDC COVER | 60.A36V1.001 |
|    |     | DIMM COVER W/SCREWS                            | 60.A36V1.007 |
| Communication Module                                                                |     |                                                |              |
|    |     | BLUETOOTH ANTENNA                              | 50.A36V1.001 |
|   |     | WIRELESS ANTENNA LEFT/RIGHT                    | 50.A36V1.002 |
| CPU                                                                                 |     |                                                |              |
|  |     | CPU SEMPRON 2800+ 62W AMD                      | KC.A2802.62D |
|                                                                                     |     | CPU NB SEMPRON 3000+ 62W AMD                   | KC.A3002.62D |
| HDD/ Hard Disk Drive                                                                |     |                                                |              |
|  |     | HDD 40G HITACHI 4200RPM 13G1132                | KH.04007.010 |
|                                                                                     |     | HDD 40G TOSHIBA MK4025GAS                      | KH.04004.002 |
|                                                                                     |     | HDD 40G 4200PRM SEAGATE ST94019A               | KH.04001.010 |
|                                                                                     |     | HDD 60G HITACHI C25N060ATMR04                  | KH.06007.006 |
|                                                                                     |     | HDD 60G TOSHIBA MK6025GAS                      | KH.06004.003 |
|                                                                                     |     | HDD 80G HITACHI IC25N080ATMR04                 | KH.08007.007 |
|                                                                                     |     | HDD 80G TOSHIBA MK8025GAS KA023A               | KH.08004.001 |

## Aspire 1360

| Picture                                                                             | No. | Partname And Description            | Part Number  |
|-------------------------------------------------------------------------------------|-----|-------------------------------------|--------------|
|    | 16  | HDD BRACKET                         | 33.E02V1.001 |
| Heatsink                                                                            |     |                                     |              |
|    |     | CPU THERMAL PLATE                   | 34.A30V1.001 |
|    |     | CPU HEATSINK W/FAN                  | 34.A36V1.001 |
|    |     | VGA THERMAL PLATE                   | 33.A36V1.00  |
|                                                                                     |     | VGA THERMAL PLATE (FOR UMA)         | 33.A36V1.003 |
| Keyboard                                                                            |     |                                     |              |
|  |     | KEYBOARD DARFON NSK-ACD1D US INT    | KB.A3007.019 |
|                                                                                     | 2   | KEYBOARD DARFON NSK-ACD00 SWISS     | KB.A3007.016 |
|                                                                                     |     | KEYBOARD DARFON NSK-ACD02 TAIWAN    | KB.A3007.020 |
|                                                                                     |     | KEYBOARD DARFON NSK-ACD03 THAILAND  | KB.A3007.022 |
|                                                                                     |     | KEYBOARD DARFON NSK-ACD06 PORTUGUES | KB.A3007.004 |
|                                                                                     |     | KEYBOARD DARFON NSK-ACD0A ARABIC    | KB.A3007.005 |
|                                                                                     |     | KEYBOARD DARFON NSK-ACD0C CZECH     | KB.A3007.008 |
|                                                                                     |     | KEYBOARD DARFON NSK-ACD0D DANISH    | KB.A3007.011 |
|                                                                                     |     | KEYBOARD DARFON NSK-ACD0E ITALIAN   | KB.A3007.003 |
|                                                                                     |     | KEYBOARD DARFON NSK-ACD0F FRENCH    | KB.A3007.015 |

## Aspire 1360

| Picture                                                                             | No. | Partname And Description                       | Part Number  |
|-------------------------------------------------------------------------------------|-----|------------------------------------------------|--------------|
|                                                                                     |     | KEYBOARD DARFON NSK-ACD0G<br>GERMAN            | KB.A3007.002 |
|                                                                                     |     | KEYBOARD DARFON NSK-ACD0K<br>KOREAN            | KB.A3007.018 |
|                                                                                     |     | KEYBOARD DARFON NSK-ACD0L<br>GREEK             | KB.A3007.017 |
|                                                                                     |     | KEYBOARD DARFON NSK-ACD0M<br>FRENCH/CANADIAN   | KB.A3007.013 |
|                                                                                     |     | KEYBOARD DARFON NSK-ACD0N<br>NORWEGIAN         | KB.A3007.010 |
|                                                                                     |     | KEYBOARD DARFON NSK-ACD0Q<br>HUNGARIAN         | KB.A3007.009 |
|                                                                                     |     | KEYBOARD DARFON NSK-ACD0R<br>RUSSIAN           | KB.A3007.014 |
|                                                                                     |     | KEYBOARD DARFON NSK-ACD0S<br>SPANISH           | KB.A3007.021 |
|                                                                                     |     | KEYBOARD DARFON NSK-ACD0T<br>TURKISH           | KB.A3007.012 |
|                                                                                     |     | KEYBOARD DARFON NSK-ACD0U UK                   | KB.A3007.001 |
|                                                                                     |     | KEYBOARD DARFON NSK-ACD0W<br>SWEDISH/FINNISH   | KB.A3007.007 |
|                                                                                     |     | KEYBOARD DARFON NSK-ACD1A<br>BELGIAN           | KB.A3007.006 |
|                                                                                     |     | KEYBOARD DARFON NSK-ACD1B<br>BRAZILIAN         | KB.A3007.023 |
| LCD                                                                                 |     |                                                |              |
|  |     | LCD MODULE 15.4" WXGA W/<br>ANTENNA(QDI)       | 6M.A36V1.004 |
|                                                                                     |     | LCD MODULE 15.4" WXGA W/<br>ANTENNA(AU)        | 6M.A36V1.005 |
|                                                                                     |     | LCD MODULE 15.4" WXGA W/<br>ANTENNA(HITACHI)   | 6M.A36V1.006 |
|                                                                                     |     | LCD 15" AU B150XG02 V.2                        | LK.15005.007 |
|                                                                                     |     | LCD 15" XGA SAMSUNG LTN150XB-<br>L03           | LK.15006.005 |
|  |     | LCD 15.4" HITACHI TX39D85VC1F                  | LK.15404.003 |
|                                                                                     |     | LCD 15.4" CMO WXGA N154I1-L02                  | LK.1540D.002 |
|                                                                                     |     | LCD 15.4" WXGA AU B154EW01 V.5                 | LK.15405.002 |
|                                                                                     |     | INVERTER BOARD 15" SUMIDA TWS-<br>458-031      | 19.T30V1.201 |
|  |     | IINVERTER BOARD 15.4" SUMIDA<br>IV11117/T R.1B | 19.A30V1.101 |
|                                                                                     |     | INVERTER BOARD 15.4" DARFON<br>V0.21071.301    | 19.A36V1.001 |

## Aspire 1360

| Picture                                                                             | No. | Partname And Description        | Part Number  |
|-------------------------------------------------------------------------------------|-----|---------------------------------|--------------|
|    |     | LCD BRACKET 15.4" RIGHT         | 33.A36V1.001 |
|                                                                                     |     | LCD BRACKET ASSEMBLY 15.1 RIGHT | 33.A36V1.004 |
|    | NS  | LCD BRACKET 15.4" LEFT          | 33.A36V1.002 |
|                                                                                     |     | LCD BRACKET ASSEMBLY 15.1 LEFT  | 33.A36V1.003 |
|                                                                                     |     | INVERTER CABLE                  | 50.A36V1.004 |
|    |     | INVERTER CABLE                  | 50.A30V1.001 |
|  |     | LCD COAXIAL CABLE 15.4"         | 50.A30V1.002 |
|                                                                                     |     | LCD COAXIAL CABLE 15.4"         | 50.A30V1.003 |
|                                                                                     |     | LCD COAXIAL CABLE 15.1          | 50.A36V1.003 |
|  | NS  | LCD PANEL 15.4" W/HINGE & LOGO  | 60.A30V1.005 |
|                                                                                     |     | LCD PANEL 15" W/HINGE & LOGO    | 60.A36V1.005 |
|  | NS  | LCD BEZEL 15.4" W/ICON PLATE    | 60.A30V1.004 |
|                                                                                     |     | LCD BEZEL 15" W/ICON PLATE      | 60.A36V1.004 |
|                                                                                     |     | HINGE PACK LEFT/RIGHT           | TBD          |

## Aspire 1360

| Picture                                                                             | No. | Partname And Description                                               | Part Number  |
|-------------------------------------------------------------------------------------|-----|------------------------------------------------------------------------|--------------|
|    |     | HINGE PACK 15" LEFT/RIGHT                                              | 6K.A36V1.001 |
| <b>Main Board</b>                                                                   |     |                                                                        |              |
|    |     | MAINBOARD W/LAUNCH BOARD CABLE & MODEM CABLE & RTC BATTERY             | TBD          |
|                                                                                     |     | MAINBOARD W/LAUNCH BOARD CABLE & MODEM CABLE & RTC BATTERY & VGA BOARD | TBD          |
|                                                                                     |     | PCMCIA SLOT                                                            | 22.T30V1.001 |
| <b>Miscellaneous</b>                                                                |     |                                                                        |              |
|    |     | TOUCHPAD BUTTON                                                        | 42.A30V1.005 |
|                                                                                     |     | LCD SCREW CAP LOWER                                                    | 47.A16V1.001 |
|                                                                                     |     | LCD SCREW RUBBER UPPER                                                 | 47.A16V1.002 |
|  |     | ICON PLATE                                                             | 40.A30V1.001 |
|  |     | LOGO PLATE                                                             | 31.A30V1.001 |
| <b>Memory</b>                                                                       |     |                                                                        |              |
|  | NS  | SODIMM 256M NANYA NT256D64SH8BAGM-6K                                   | KN.25603.009 |
|                                                                                     |     | SODIMM 256M SAMSUNG M470L3224FT0-CB3                                   | KN.2560B.008 |
|                                                                                     |     | SODIMM 256M MICRON MT8VDDT3264HDG-335F4                                | KN.25604.021 |
|                                                                                     |     | SODIMM 256M INFINEON HYS64D32020HDL-6-C                                | KN.25602.012 |
|                                                                                     |     | SODIMM 512M INFINEON HYS64D64020GBDL-6-C                               | KN.51202.013 |
|                                                                                     |     | SODIMM 512M MICRON MT8VDDT6464HDG-335C1                                | KN.51204.013 |
|                                                                                     |     | SODIMM 512M SAMSUNG M470L6524BT0-CB3                                   | KN.5120B.006 |
| <b>Optical Drive</b>                                                                |     |                                                                        |              |

## Aspire 1360

| Picture                                                                             | No. | Partname And Description                   | Part Number  |
|-------------------------------------------------------------------------------------|-----|--------------------------------------------|--------------|
|    |     | CDRW/DVD COMBO MODULE 24X                  | 6M.A36V1.002 |
|                                                                                     |     | DVD-RW MODULE 4X                           | 6M.A36V1.003 |
|    |     | CDRW/DVD COMBO DRIVE 24x QSI SBW-242B      | KO.02407.012 |
|                                                                                     |     | CDRW/DVD COMBO DRIVE 24X PANASONIC UJDA760 | KO.02406.001 |
|                                                                                     |     | DVD-RW 4X QSI SDW-042 DUAL                 | KU.00403.003 |
|    |     | OPTICAL BRACKET                            | 33.T30V1.004 |
| PCMCIA slot/PC card slot                                                            |     |                                            |              |
|    |     | PCMCIA SLOT                                | 22.T30V1.001 |
| Pointing Device                                                                     |     |                                            |              |
|  | NS  | TOUCHPAD BOARD SYNAPTICS TM41P-357         | 56.17001.001 |
| Speaker                                                                             |     |                                            |              |
|  |     | SPEAKER                                    | 23.A30V1.001 |
| Screws                                                                              |     |                                            |              |
|                                                                                     | NS  | SCW HEX NYL I#R-40/O#4-40 L5.5             | 34.00015.081 |
|                                                                                     | NS  | SCRW THERMAL MODULE FOR J8                 | 86.00B54.630 |
|                                                                                     | NS  | SCREW M2*3 NYLON 1JMCPC-420325             | 86.9A352.3R0 |
|                                                                                     | NS  | SCREW M2.5X6                               | 86.9A353.6R0 |
|                                                                                     | NS  | SRW M2.5*8L B/ZN NYLOK 700                 | 86.9A353.8R0 |
|                                                                                     | NS  | SCREW M3x4(86.9A524.4R0)                   | 86.9A524.4R0 |
|                                                                                     | NS  | SCREW M2X2.0                               | 86.9A552.2R0 |
|                                                                                     | NS  | SCREW WAFER NYLOK NI 2ML3                  | 86.9A552.3R0 |
|                                                                                     | NS  | SCRW M2*4 WAFER NI                         | 86.9A552.4R0 |

---

**Aspire 1360**

| Picture | No. | Partname And Description | Part Number  |
|---------|-----|--------------------------|--------------|
|         | NS  | SCRW M2.5*3 WAFER NI     | 86.9A553.3R0 |
|         |     | SCRW M2.5*3 WAFER NI     | 86.9A553.3R0 |
|         | NS  | SCREW M2.5*4L NI         | 86.9A553.4R0 |



## Aspire 1520

| Picture                                                                             | No. | Partname And Description                                | Part Number  |
|-------------------------------------------------------------------------------------|-----|---------------------------------------------------------|--------------|
| <b>Adapter</b>                                                                      |     |                                                         |              |
|                                                                                     | N/S | ADAPTER 19V 90W 3PIN LITEON PA-1900-05QA                | TBD          |
|                                                                                     | N/S | ADAPTER 19V 90W 3PIN DELTA ADP-90SB                     | TBD          |
| <b>Battery</b>                                                                      |     |                                                         |              |
|    | N/S | RTC BATTERY LONGTRUM                                    | 23.T30V1.001 |
|    | 18  | BATTERY MODULE LI 8CELL 2000MAH SANYO                   | 6M.A36V1.001 |
|    | N/S | BATTERY LI 8CELL 2000MAH SANYO BTP-60A1                 | BT.T3003.001 |
|                                                                                     | N/S | BATTERY LI 8CELL SIMPLO BTP-58A1                        | BT.T3007.003 |
| <b>CASE/COVER/BRACKET ASSEMBLY</b>                                                  |     |                                                         |              |
|  |     | BATTERY COVER<br>(The cover should be silver not black) | 42.A30V1.001 |
| <b>Boards</b>                                                                       |     |                                                         |              |
|  |     | VGA BOARD NV36-64M(DIP)                                 | TBD          |
|  |     | DC-DC CHARGER BOARD                                     | 55.T30V1.001 |

## Aspire 1520

| Picture                                                                             | No. | Partname And Description                  | Part Number  |
|-------------------------------------------------------------------------------------|-----|-------------------------------------------|--------------|
|    |     | WIRELESS LAN BOARD 802.11BG<br>FOXCONN    | 54.A36V1.001 |
|    |     | MODEM BOARD AMBIT<br>T60M283.10(01)       | 54.09011.544 |
|                                                                                     |     | MODEM/BLEETOOTH BOARD AMBIT<br>T60M665.00 | 54.09061.001 |
|    |     | LAUNCH BOARD                              | 55.T30V1.002 |
| Cables                                                                              |     |                                           |              |
|                                                                                     |     | POWER CORD 10A 125V US                    | 27.01518.311 |
|    |     | COVER SWITCH CABLE                        | 50.A30V1.004 |
|  |     | LAUNCH BOARD CABLE                        | 50.T30V1.011 |
|  |     | MODEM CABLE 2PIN 2CONNECTOR<br>55MM       | 50.41T11.002 |
| Case/Cover/Bracket Assembly                                                         |     |                                           |              |
|  |     | MODEM COVER W/SCREWS                      | 42.A20V1.001 |
|  |     | HINGE CAP RIGHT                           | 42.A30V1.002 |

## Aspire 1520

| Picture                                                                             | No. | Partname And Description                                     | Part Number  |
|-------------------------------------------------------------------------------------|-----|--------------------------------------------------------------|--------------|
|    |     | HINGE CAP LEFT                                               | 42.A30V1.003 |
|    |     | HDD SUPPORT BRACKET                                          | 33.A30V1.002 |
|    |     | OPTICAL DEVICE SUPPORT BRACKET                               | 33.A30V1.001 |
|   |     | 2ND FAN BRACKET                                              | 33.A20V1.002 |
|  |     | TOUCHPAD COVER                                               | 42.A30V1.004 |
|  |     | MIDDLE COVER HOOK                                            | 31.A20V1.001 |
|  |     | UPPER CASE W/COVERSWITCH CABLE & TOUCHPAD CABLE & SCROLL KEY | 60.A36V1.002 |
|  |     | MIDDLE COVER W/LAUNCH BOARD                                  | 60.A36V1.003 |

## Aspire 1520

| Picture                                                                             | No. | Partname And Description                       | Part Number  |
|-------------------------------------------------------------------------------------|-----|------------------------------------------------|--------------|
|    |     | LOWER CASE W/DIMM COVER& SPEAKER W/O MDC COVER | 60.A36V1.001 |
|    |     | DIMM COVER W/SCREWS                            | 60.A36V1.007 |
| Communication Module                                                                |     |                                                |              |
|    |     | WIRELESS ANTENNA RIGHT (BLACK)                 | 50.A20V1.001 |
|    |     | WIRELESS ANTENNA LEFT (GRAY)                   | 50.A20V1.002 |
|  |     | BLUETOOTH ANTENNA                              | 50.A36V1.001 |
| CPU                                                                                 |     |                                                |              |
|  |     | CPU SEMPRON 2800+ 62W AMD                      | KC.A2802.62D |
|                                                                                     |     | CPU NB SEMPRON 3000+ 62W AMD                   | KC.A3002.62D |
| HDD/ Hard Disk Drive                                                                |     |                                                |              |
|  |     | HDD 40G HITACHI 4200RPM 13G1132                | KH.04007.010 |
|                                                                                     |     | HDD 40G TOSHIBA MK4025GAS                      | KH.04004.002 |
|                                                                                     |     | HDD 40G 4200PRM SEAGATE ST94019A               | KH.04001.010 |
|                                                                                     |     | HDD 60G HITACHI C25N060ATMR04                  | KH.06007.006 |
|                                                                                     |     | HDD 60G TOSHIBA MK6025GAS                      | KH.06004.003 |
|                                                                                     |     | HDD 80G HITACHI IC25N080ATMR04                 | KH.08007.007 |

## Aspire 1520

| Picture                                                                             | No. | Partname And Description               | Part Number  |
|-------------------------------------------------------------------------------------|-----|----------------------------------------|--------------|
|                                                                                     |     | HDD 80G TOSHIBA MK8025GAS<br>KA023A    | KH.08004.001 |
|    | 16  | HDD BRACKET                            | 33.E02V1.001 |
| <b>Heatsink</b>                                                                     |     |                                        |              |
|    |     | CPU THERMAL PLATE                      | 34.A30V1.001 |
|    |     | CPU HEATSINK W/FAN                     | 34.A36V1.001 |
|   |     | VGA THERMAL PLATE                      | 33.A36V1.00  |
|                                                                                     |     | VGA THERMAL PLATE (FOR UMA)            | 33.A36V1.003 |
| <b>Keyboard</b>                                                                     |     |                                        |              |
|  |     | KEYBOARD DARFON NSK-ACD1D US<br>INT    | KB.A3007.019 |
|                                                                                     | 2   | KEYBOARD DARFON NSK-ACD00<br>SWISS     | KB.A3007.016 |
|                                                                                     |     | KEYBOARD DARFON NSK-ACD02<br>TAIWAN    | KB.A3007.020 |
|                                                                                     |     | KEYBOARD DARFON NSK-ACD03<br>THAILAND  | KB.A3007.022 |
|                                                                                     |     | KEYBOARD DARFON NSK-ACD06<br>PORTUGUES | KB.A3007.004 |
|                                                                                     |     | KEYBOARD DARFON NSK-ACD0A<br>ARABIC    | KB.A3007.005 |
|                                                                                     |     | KEYBOARD DARFON NSK-ACD0C<br>CZECH     | KB.A3007.008 |
|                                                                                     |     | KEYBOARD DARFON NSK-ACD0D<br>DANISH    | KB.A3007.011 |
|                                                                                     |     | KEYBOARD DARFON NSK-ACD0E<br>ITALIAN   | KB.A3007.003 |

## Aspire 1520

| Picture                                                                             | No. | Partname And Description                      | Part Number  |
|-------------------------------------------------------------------------------------|-----|-----------------------------------------------|--------------|
|                                                                                     |     | KEYBOARD DARFON NSK-ACD0F<br>FRENCH           | KB.A3007.015 |
|                                                                                     |     | KEYBOARD DARFON NSK-ACD0G<br>GERMAN           | KB.A3007.002 |
|                                                                                     |     | KEYBOARD DARFON NSK-ACD0K<br>KOREAN           | KB.A3007.018 |
|                                                                                     |     | KEYBOARD DARFON NSK-ACD0L<br>GREEK            | KB.A3007.017 |
|                                                                                     |     | KEYBOARD DARFON NSK-ACD0M<br>FRENCH/CANADIAN  | KB.A3007.013 |
|                                                                                     |     | KEYBOARD DARFON NSK-ACD0N<br>NORWEGIAN        | KB.A3007.010 |
|                                                                                     |     | KEYBOARD DARFON NSK-ACD0Q<br>HUNGARIAN        | KB.A3007.009 |
|                                                                                     |     | KEYBOARD DARFON NSK-ACD0R<br>RUSSIAN          | KB.A3007.014 |
|                                                                                     |     | KEYBOARD DARFON NSK-ACD0S<br>SPANISH          | KB.A3007.021 |
|                                                                                     |     | KEYBOARD DARFON NSK-ACD0T<br>TURKISH          | KB.A3007.012 |
|                                                                                     |     | KEYBOARD DARFON NSK-ACD0U UK                  | KB.A3007.001 |
|                                                                                     |     | KEYBOARD DARFON NSK-ACD0W<br>SWEDISH/FINNISH  | KB.A3007.007 |
|                                                                                     |     | KEYBOARD DARFON NSK-ACD1A<br>BELGIAN          | KB.A3007.006 |
|                                                                                     |     | KEYBOARD DARFON NSK-ACD1B<br>BRAZILIAN        | KB.A3007.023 |
| LCD                                                                                 |     |                                               |              |
|  |     | LCD MODULE 15.4" WXGA W/<br>ANTENNA(QDI)      | 6M.A30V1.001 |
|                                                                                     |     | LCD MODULE 15.4" WXGA W/<br>ANTENNA(AU)       | 6M.A30V1.002 |
|                                                                                     |     | LCD MODULE 15.4" WXGA W/<br>ANTENNA(HITACHI)  | 6M.A30V1.003 |
|                                                                                     |     | LCD MODULE 15.4" WXGA W/O<br>ANTENNA(QDI)     | 6M.A30V1.005 |
|                                                                                     |     | LCD MODULE 15.4" WXGA W/O<br>ANTENNA(AU)      | 6M.A30V1.006 |
|                                                                                     |     | LCD MODULE 15.4" WXGA W/O<br>ANTENNA(HITACHI) | 6M.A30V1.007 |
|  |     | LCD 15.4" WXGA QDI                            | LK.15409.001 |
|                                                                                     |     | LCD 15.4" WXGA AU                             | LK.15405.001 |
|                                                                                     |     | LCD 15.4" WXGA HITACHI                        | LK.15404.001 |
|  |     | INVERTER BOARD 15.4" SUMIDA                   | 19.A30V1.001 |

## Aspire 1520

| Picture                                                                             | No. | Partname And Description                                                                | Part Number  |
|-------------------------------------------------------------------------------------|-----|-----------------------------------------------------------------------------------------|--------------|
|    |     | LCD BRACKET 15.4" RIGHT                                                                 | 33.A30V1.004 |
|    | NS  | LCD BRACKET 15.4" LEFT                                                                  | 33.A30V1.005 |
|    |     | INVERTER CABLE                                                                          | 50.A30V1.001 |
|   |     | LCD COAXIAL CABLE 15.4"                                                                 | 50.A30V1.003 |
|  | NS  | LCD PANEL 15.4" W/HINGE & LOGO                                                          | 60.A30V1.005 |
|  | NS  | LCD BEZEL 15.4" W/ICON PLATE                                                            | 60.A30V1.004 |
|                                                                                     |     | HINGE PACK LEFT/RIGHT                                                                   | TBD          |
| Main Board                                                                          |     |                                                                                         |              |
|  |     | MAINBOARD YUHINA 4 W/LAUNCH BOARD CABLE & MODEM CABLE & RTC BATTERY (DISCREET VGA-M11P) | LB.A2001.001 |
|                                                                                     |     | PCMCIA SLOT                                                                             | 22.T30V1.001 |
| Miscellaneous                                                                       |     |                                                                                         |              |

## Aspire 1520

| Picture                                                                             | No. | Partname And Description                      | Part Number  |
|-------------------------------------------------------------------------------------|-----|-----------------------------------------------|--------------|
|    |     | TOUCHPAD BUTTON                               | 42.A30V1.005 |
|                                                                                     |     | LCD SCREW CAP LOWER                           | 47.A16V1.001 |
|                                                                                     |     | LCD SCREW RUBBER UPPER                        | 47.A16V1.002 |
|    |     | ICON PLATE                                    | 40.A30V1.001 |
|    |     | LOGO PLATE                                    | 31.A30V1.001 |
| Memory                                                                              |     |                                               |              |
|    | NS  | SODIMM 256M NANYA<br>NT256D64SH8BAGM-6K       | KN.25603.009 |
|                                                                                     |     | SODIMM 256M SAMSUNG<br>M470L3224FT0-CB3       | KN.2560B.008 |
|                                                                                     |     | SODIMM 256M MICRON<br>MT8VDDT3264HDG-335F4    | KN.25604.021 |
|                                                                                     |     | SODIMM 256M INFINEON<br>HYS64D32020HDL-6-C    | KN.25602.012 |
|                                                                                     |     | SODIMM 512M INFINEON<br>HYS64D64020GBDL-6-C   | KN.51202.013 |
|                                                                                     |     | SODIMM 512M MICRON<br>MT8VDDT6464HDG-335C1    | KN.51204.013 |
|                                                                                     |     | SODIMM 512M SAMSUNG<br>M470L6524BT0-CB3       | KN.5120B.006 |
| Optical Drive                                                                       |     |                                               |              |
|  |     | CDRW/DVD COMBO MODULE 24X                     | 6M.A36V1.002 |
|                                                                                     |     | DVD-RW MODULE 4X                              | 6M.A36V1.003 |
|  |     | CDRW/DVD COMBO DRIVE 24x QSI<br>SBW-242B      | KO.02407.012 |
|                                                                                     |     | CDRW/DVD COMBO DRIVE 24X<br>PANASONIC UJDA760 | KO.02406.001 |
|                                                                                     |     | DVD-RW 4X QSI SDW-042 DUAL                    | KU.00403.003 |



## Aspire 1520

| Picture                                                                            | No. | Partname And Description              | Part Number  |
|------------------------------------------------------------------------------------|-----|---------------------------------------|--------------|
|   |     | OPTICAL BRACKET                       | 33.T30V1.004 |
| PCMCIA slot/PC card slot                                                           |     |                                       |              |
|   |     | PCMCIA SLOT                           | 22.T30V1.001 |
| Pointing Device                                                                    |     |                                       |              |
|   | NS  | TOUCHPAD BOARD SYNAPTICS<br>TM41P-357 | 56.17001.001 |
| Speaker                                                                            |     |                                       |              |
|  |     | SPEAKER                               | 23.A30V1.001 |
| Screws                                                                             |     |                                       |              |
|                                                                                    | NS  | SCW HEX NYL I#R-40/O#4-40 L5.5        | 34.00015.081 |
|                                                                                    | NS  | SCRW THERMAL MODULE FOR J8            | 86.00B54.630 |
|                                                                                    | NS  | SCREW M2*3 NYLON 1JMCPC-420325        | 86.9A352.3R0 |
|                                                                                    | NS  | SCREW M2.5X6                          | 86.9A353.6R0 |
|                                                                                    | NS  | SRW M2.5*8L B/ZN NYLOK 700            | 86.9A353.8R0 |
|                                                                                    | NS  | SCREW M3x4(86.9A524.4R0)              | 86.9A524.4R0 |
|                                                                                    | NS  | SCREW M2X2.0                          | 86.9A552.2R0 |
|                                                                                    | NS  | SCREW WAFER NYLOK NI 2ML3             | 86.9A552.3R0 |
|                                                                                    | NS  | SCRW M2*4 WAFER NI                    | 86.9A552.4R0 |
|                                                                                    | NS  | SCRW M2.5*3 WAFER NI                  | 86.9A553.3R0 |
|                                                                                    |     | SCRW M2.5*3 WAFER NI                  | 86.9A553.3R0 |
|                                                                                    | NS  | SCREW M2.5*4L NI                      | 86.9A553.4R0 |



# Model Definition and Configuration

## Model Name Definition

### Aspire 1360

| Model Number | LCD        | CPU                          | Memory         | HDD  | ODD        | Wireless LAN | VGA                           |
|--------------|------------|------------------------------|----------------|------|------------|--------------|-------------------------------|
| 1362LMi      | 15.0" XGA  | Mobile AMD Sempron 2800+ 62W | 2x256MB        | 60GB | 8xDVD-Dual | 802.11g      | NVIDIA GeForce FX Go5200 64MB |
| 1362WLMi     | 15.4" WXGA | Mobile AMD Sempron 2800+ 62W | 2x256MB        | 40GB | 8xDVD-Dual | 802.11g      | NVIDIA GeForce FX Go5200 64MB |
| 1363WLMi     | 15.4" WXGA | Sempron 3000+ 62W            | 2x256MB        | 60GB | 8xDVD-Dual | 802.11g      | NVIDIA GeForce FX Go5200 64MB |
| 1362XC       | 14.1" XGA  | Sempron 2800+ 62W            | DDR333 1x256MB | 30GB | 24x Combo  | N/A          | UMA                           |
| 1362LC       | 15.0" XGA  | Sempron 2800+ 62W            | DDR333 1x256MB | 40GB | 24x Combo  | N/A          | UMA                           |
| 1362LCi      | 15.0" XGA  | Sempron 2800+ 62W            | DDR333 2x256MB | 60GB | 24x Combo  | 802.11g      | UMA                           |
| 1362WLC      | 15.4" WXGA | Sempron 2800+ 62W            | DDR333 2x256MB | 40GB | 24x Combo  | N/A          | UMA                           |
| 1362WLCi     | 15.4" WXGA | Sempron 2800+ 62W            | DDR333 2x256MB | 40GB | 24x Combo  | 802.11g      | UMA                           |

### Aspire 1520

| Model Number | LCD        | CPU                 | Memory        | HDD  | ODD/Card Reader                    | Wireless LAN    | VGA                           |
|--------------|------------|---------------------|---------------|------|------------------------------------|-----------------|-------------------------------|
| 1522LMi      | 15.0" XGA  | AMD Athlon 64 3000+ | 512MB (2*256) | 40GB | DVD-Dual/PCMCIA 4-in-1 card reader | Ethernet & 11 g | NVIDIA Geforce FX Go5700 64MB |
| 1522WLMi     | 15.4" WXGA | AMD Athlon 64 3000+ | 512MB (2*256) | 60GB | DVD-Dual/PCMCIA 4-in-1 card reader | Ethernet & 11 g | NVIDIA Geforce FX Go5700 64MB |
| 1524WLMi     | 15.4" WXGA | AMD Athlon 64 3400+ | 512MB (2*256) | 60GB | DVD-Dual/PCMCIA 4-in-1 card reader | Ethernet & 11 g | NVIDIA Geforce FX Go5700 64MB |

---

**Aspire 1520**

| <b>Model Number</b> | <b>LCD</b>   | <b>CPU</b>                    | <b>Memory</b>    | <b>HDD</b> | <b>ODD/Card Reader</b> | <b>Wireless LAN</b> | <b>VGA</b>     |
|---------------------|--------------|-------------------------------|------------------|------------|------------------------|---------------------|----------------|
| 1522LC              | 15.0"<br>XGA | AMD Athlon<br>64 3000+<br>82W | 512MB<br>(2*256) | 40GB       | 24x Combo              | N                   | 64MB<br>shared |

# Test Compatible Components

---

This computer's compatibility is a test plan released by Acer Internal Testing Department. Once the final report is available, this chapter will be revised accordingly.

# Microsoft Windows XP Environment Test

| Item            | Specifications                                                                                                                                                                                                                                                                                        |
|-----------------|-------------------------------------------------------------------------------------------------------------------------------------------------------------------------------------------------------------------------------------------------------------------------------------------------------|
| Processor       | AMD Athlon 64 DTR 3400+<br>AMD Athlon 64 DTR 3000+<br>AMD Mobile Athlon XP-M 3000+<br>AMD Sempron 3000+<br>AMD Sempron 2800+                                                                                                                                                                          |
| Memory          | 256MB:<br>Nanya NT256D64SH8BAGM-6K (.14u)<br>Samsung M470L3224FT0-CB3 (.13u)<br>Infineon HYS64D32020HDL-6-C 32x64 (.11u/G)<br>Micron MT8VDDT3264HDG-335F4 (.11u)<br>512MB:<br>Infineon HYS64D64020GBDL-6-C (.11u/B)<br>Micron MT8VDDT6464HDG-335C1 (.11u/512Mb)<br>Samsung M470L6524BT0-CB300 (512Mb) |
| LCD             | 15.4" WXGA<br>Samsung LTN154X1-L02<br>HITACHI TX39D85VC1FAA (low cost)<br>CMO N154I1-L09 (low cost)<br>AUO B154EW01 V.5 (low cost)                                                                                                                                                                    |
|                 | 14.1" XGA<br>AUO B141XG10<br>CMO N141XB-L01<br>Toppoly TD141TGCD1                                                                                                                                                                                                                                     |
|                 | 15" XGA TFT<br>AUO B150XG02<br>CMO N150X3-L07<br>LG LP150X08-A3<br>Hitachi TX38D81VC1CAB Rev. B<br>SAMSUNG LTN150XB-L03-C00                                                                                                                                                                           |
|                 | 15" SXGA+ TFT<br>AUO B150PG01(NEC)<br>IDT(CMO) N150P2-L04<br>SAMSUNG LTN150P4-L03                                                                                                                                                                                                                     |
| Hard Disk Drive | 30GB HGST Moraga+ HTS24030M9AT00<br>30GB Toshiba Pluto MK3025GAS                                                                                                                                                                                                                                      |
|                 | 40GB IBM HGST Moraga +, HTS424040M9AT00 13G1132<br>40GB TOSHIBA Pluto, MK4025GAS ,KA100A<br>40G Seagate N1, ST94019A, 2MB                                                                                                                                                                             |
|                 | 60G HGST Moraga IC25N060ATMR04-0<br>60G TOSHIBA Pluto, MK6025GAS                                                                                                                                                                                                                                      |
|                 | 80G HGST Moraga, IC25N080ATMR04-0 08K635<br>80G TOSHIBA Pluto, MK8025GAS, 8MB                                                                                                                                                                                                                         |
| Combo           | QSI Combo 24X QSI/SBW-242B w/ standard bazel<br>KME Combo 24X , Panasonic 24X COMBO UJDA-760 EGRET BZL<br>HLDS Combo 24X HLDS GCC-4243N w/ standard bazel                                                                                                                                             |

| Item                                    | Specifications                                                                                                                                                                                                                 |
|-----------------------------------------|--------------------------------------------------------------------------------------------------------------------------------------------------------------------------------------------------------------------------------|
| DVD Dual                                | QSI DVD Dual 4X, QSI SDW-042 w/ standard bezel<br>Lite-On DVD Dual 8X , LiteOn SOSW-852S w/ standard bezel<br>Toshiba DVD Dual 8X, Toshiba L532A w/ standard bezel<br>Pioneer DVD-dual 8X, Pioneer DVR K14RA w/ stantard bezel |
| AC Adapter (3 pin)                      | 135W:<br>Hipro Adapter 135W<br>Lite-on ADT 135W 3P19V PA-1131 Y3 REV02<br>Delta ADT 19V135W3P ADP-135DB BBB YU<br>90W:<br>Lite-on ADT 19V90W3P PA-1900-05QA EGRT<br>Delta ADT 19V90W3P ADP-90SB BBE EGRT                       |
| Battery Li-Ion, 8 cells                 | SANYO BTP-60A1<br>SIMPLO BTY PK Panasonic                                                                                                                                                                                      |
| Network Adapters                        |                                                                                                                                                                                                                                |
| LAN Ethernet/10baseT/100base            | 3Com Etherlink III 3C589D<br>IBM EtherJet CardBus<br>Intel Ether Express Pro/100 Mobile Adapter MBLA3200<br>Xircom CardBus Ethernet 10/100 32 Bit CBE-10/100BTX                                                                |
| Multifunction Card (Combo)              | 3Com Megahertz 10/100 LAN + 56K Modem PC Card<br>Xircom RealPort CardBus Ethenet 10/100 + Modem 56                                                                                                                             |
| LAN Token Ring                          | IBM Token Ring 16/4 Adapter II                                                                                                                                                                                                 |
| Wireless LAN Card                       | IBM Wireless LAN Cardbus Adapter<br>Intel Pro-Wireless LAN PC Card<br>Proxim Skyline 802.11a Cardbus PC Card<br>Cisco Aironet 350 series Wireless Lan Card<br>NeWeb Wireless Lan Card 802.11b                                  |
| Modem Adapters                          |                                                                                                                                                                                                                                |
| Modem (up to 56K)                       | 3Com Megahertz 56K Modem PC Card<br>Xircom CreditCard Modem 56<br>IBM 56K Double Jack Modem                                                                                                                                    |
| ISDN                                    | US Robotics Megahertz 128K ISDN Card<br>IBM OBI International ISDN PC Card                                                                                                                                                     |
| I/O Peripheral                          |                                                                                                                                                                                                                                |
| I/O - Display                           | Acer 211c 21"<br>Viewsonic PF790 19"<br>Acer FP751 17" TFT LCD<br>IBM Color TFT LCD 14"<br>Compaq Color Monitor<br>NET Color Monitor 20"<br>Mozo 17" TFT LCD                                                                   |
| I/O - Projector                         | NEC MultiSync MT-1040                                                                                                                                                                                                          |
| I/O - Legacy (Parallel) Printer/Scanner | Canon BJC-600J<br>Epson Stylus Color 740 Parallel Interface<br>HP DeskJet 890C<br>HP DeskJet 880C Parallel Interface<br>HP LaserJet 6MP<br>HP LaserJet 2200                                                                    |
| I/O - IR Printer                        | HP LaserJet 6MP use IR<br>HP LaserJet 2200 use IR<br>Nokia 7210                                                                                                                                                                |

| Item                                     | Specifications                                                                                                                                                                                                                                                                                                                                                                                                    |
|------------------------------------------|-------------------------------------------------------------------------------------------------------------------------------------------------------------------------------------------------------------------------------------------------------------------------------------------------------------------------------------------------------------------------------------------------------------------|
| I/O - USB Keyboard/Mouse                 | Chicony USB Keyboard KU-8933<br>Microsoft Natural Keyboard Pro<br>Acer Aspire USB mouse<br>Logicoool US Mouse<br>Logitech Cordless Mouseman Wheel USB Interface<br>Logitech USB Wheel Mouse M-BB48<br>Microsoft IntelliMouse Optical USB Interface                                                                                                                                                                |
| I/O - Legacy (PS2/Serial) Keyboard/Mouse | IBM 101 key keyboard<br>IBM 109 key keyboard<br>Acer PS2 keyboard<br>Acer KB-101A<br>IBM Numeric Keypad III<br>IBM Numeric Keypad<br>Acer Mouse<br>IBM PS2 Mini Mouse<br>IBM PS2 Mouse<br>Logitech Cordless MouseMan Wheel PS2 interface<br>Logitech Serial Mouse M-M35<br>Microsoft IntelliMouse PS2 interface<br>Microsoft IntelliMouse Optical PS2 interface<br>Logitech First Mouse Three Button Serial Mouse |
| I/O - USB (Printer/Scanner)              | Epson Stylus Color 740 USB interface<br>HP DeskJet 880C USB interface<br>Canon CanonScan D1250 (USB 2.0, JP OS only)<br>HP ScanJet 3300C Color Scanner                                                                                                                                                                                                                                                            |
| I/O - USB (Speaker/Joystick))            | JS USB Digital Speaker<br>Panasonic USB Speaker EAB-MPC57USB<br>AIWA Multimedia Digital Speaker<br>Microsoft SideWinder Precision Pro Joystick<br>Logitech WingMan RumblePad                                                                                                                                                                                                                                      |
| I/O - USB Camera                         | Intel Easy PC Camera<br>Logitech QuickCam Express Internet<br>Logitech QuickCam Home PC Video Camera<br>Orange Micro USB 2.0 Web Cam                                                                                                                                                                                                                                                                              |
| I/O - USB Storage Drive                  | Logitech CDRW +DVDROM combo USB interface<br>Iomega USB Zip 250MB                                                                                                                                                                                                                                                                                                                                                 |
| I/O-USB Flash Drive                      | IBM 32MB USB Memory key<br>Apacer USB Handy Drive 32MB<br>Apacer USB Handy Drive 256MB                                                                                                                                                                                                                                                                                                                            |
| I/O - USB Hub                            | Belkin 4 Port USB Hub<br>Eizo I Station USB Hub<br>Elecom USB Hub 4 Port<br>Sanwa USB Hub 4 Port<br>4 Port Hub USB 2.0                                                                                                                                                                                                                                                                                            |
| I/O - Access Point (802.11b)             | Hitachi DC-CN3300<br>Lucent RG-1000<br>Lucent WavePoint-II<br>Cisco Aironet 350<br>Orinoco AP-500                                                                                                                                                                                                                                                                                                                 |
| I/O Access Point (802.11a/b)             | Intel Dual Pro/Wireless 5000                                                                                                                                                                                                                                                                                                                                                                                      |
| I/O Access Point (802.11a)               | Intel Pro/Wireless 5000                                                                                                                                                                                                                                                                                                                                                                                           |



| Item               | Specifications                                                                                                                                                                                                                         |
|--------------------|----------------------------------------------------------------------------------------------------------------------------------------------------------------------------------------------------------------------------------------|
| PCMCIA             |                                                                                                                                                                                                                                        |
| PCMCIA - ATA       | IBM Microdrive 340MB<br>IBM Microdrive 1G<br>Iomega Click! 40MB<br>Sony Memory Stick 64MB<br>Sandisk Flash Card 20MB<br>Apacer SD Flash Card 128MB<br>Apacer SD Card 256MB<br>Transcend SD Card 32MB<br>Hagiwara sys-com SD Card 256MB |
| PCMCIA - USB 2.0   | Apricorn EZ-USB2.0 Cardbus PC Card<br>DTK USB 2.0 2Port CardBus Host Controller<br>Adaptec USB2CONNECT                                                                                                                                 |
| PCMCIA - 1394      | Buffalo 1394 Interface Cardbus IFC-ILCB/DV<br>I-O Data 1394 Interface Cardbus CB1394/DVC<br>Pixela 1394 Cardbus PC Card PIX-PCMC/FW1                                                                                                   |
| PCMCIA-SCSI        | Adaptec 1408 or B SCSI CB<br>NewMedia Bus Toaster SCSI II                                                                                                                                                                              |
| PCMCIA - Bluetooth | IBM Community Bluetooth PC Card<br>Toshiba Bluetooth PC Card                                                                                                                                                                           |



## Online Support Information

---

This section describes online technical support services available to help you repair your Acer Systems.

If you are a distributor, dealer, ASP or TPM, please refer your technical queries to your local Acer branch office. Acer Branch Offices and Regional Business Units may access our website. However some information sources will require a user i.d. and password. These can be obtained directly from Acer CSD Taiwan.

Acer's Website offers you convenient and valuable support resources whenever you need them.

In the Technical Information section you can download information on all of Acer's Notebook, Desktop and Server models including:

- Service guides
- User's manuals
- Training materials
- Main manuals
- Bios updates
- Software utilities
- Spare parts lists
- Chips
- TABs (Technical Announcement Bulletin)

For these purposes, we have included an Acrobat File to facilitate the problem-free downloading of our technical material.

Also contained on this website are:

- Detailed information on Acer's International Traveller's Warranty (ITW)
- Returned material authorization procedures
- An overview of all the support services we offer, accompanied by a list of telephone, fax and email contacts for all your technical queries.

We are always looking for ways to optimize and improve our services, so if you have any suggestions or comments, please do not hesitate to communicate these to us.



**A**

AFLASH Utility 45  
Audio 18

**B**

Battery 27  
BIOS 18  
    package 18  
    ROM size 18  
    ROM type 18  
    vendor 18  
    Version 18  
BIOS Setup Utility 32  
BIOS Supports protocol 18  
BIOS Utility 32  
    Basic System Settings 37  
    Navigating 33  
    Onboard Device Configuration 40  
    Startup Configuration 39  
    System Information 33  
    System Security 44  
Board Layout  
    Bottom View 5, 99  
    Top View 4, 98  
brightness  
    hotkeys 15

**C**

CardBus 27  
CD-ROM Interface 20  
Chipsets 18  
contrast  
    hotkeys 15  
Controllers 18  
Core logic 18  
CPU  
    core voltage 18  
    I/O voltage 18  
    package 18  
    type 18

**D**

Disassembly Flowchart 48  
display  
    hotkeys 15  
Display Standby Mode 29  
DVD-ROM Interface 21

**E**

Environmental Requirements 29  
Error Symptom-to-Spare Part Index 77  
External CD-ROM Drive Check 73

**F**

Features 1  
Flash Utility 45  
FRU (Field Replaceable Unit) List 100

**H**

Hard disk 18, 20  
Hard Disk Drive Module  
    Disassembly 53  
Hard Disk Standby Mode 29  
Hardware Specifications and Configurations 18  
HDD 18, 20  
Hibernation Mode 29  
Hibernation mode  
    hotkey 15  
Hot Keys 15

**I**

Intermittent Problems 88

**J**

Jumper and Connector Locations  
    SW2 Settings 99

**K**

Keyboard 18, 27  
Keyboard or Auxiliary Input Device Check 73

**L**

L2 cache 18

**M**

Mechanical Specification 29  
Memory Check 74  
Modem 19

**N**

Notebook Manager  
    hotkey 15

## O

Online Support Information 120

## P

Panel 5, 99

    Bottom 10

Parallel Port 26

PC Card 27

PCMCIA 27

Power Management 29

Power System Check 74

    Battery Pack 76

    Power Adapter 75

## R

Removing the Battery Pack 50

RTC 18

## S

Second Level Cache 18

speakers

    hotkey 15

Standby Mode 29

Super I/O 18

System Check Procedures 73

System Diagnostic Diskette 45

System Memory 19

System Utility Diskette 45

## T

Temperature 29

Touchpad 18

touchpad

    hotkey 15

Touchpad Check 76

## U

Undetermined Problems 89

USB 26

utility

    BIOS 32

## V

Video 26

    Resolutions 26

Video controller 18

## W